



INTERNATIONAL APPLICATION PUBLISHED UNDER THE PATENT COOPERATION TREATY (PCT)

(51) International Patent Classification <sup>7</sup> : <b>H04N 1/413</b>	<b>A1</b>	(11) International Publication Number: <b>WO 00/31963</b>
		(43) International Publication Date: <b>2 June 2000 (02.06.00)</b>

(21) International Application Number: PCT/US99/27969

(22) International Filing Date: 23 November 1999 (23.11.99)

(30) Priority Data:  
60/109,718 24 November 1998 (24.11.98) US

(71) Applicant (for all designated States except US): NIKSUN, INC. [US/US]; 180 Tices Lane, East Brunswick, NJ 08816 (US).

(72) Inventors; and  
(75) Inventors/Applicants (for US only): PRUTHI, Parag [US/US]; 18 Marlow Road, East Brunswick, NJ 08816 (US). HEY-BEY, Andrew [US/US]; 4074 Robinwood Road, York, PA 17402 (US).

(74) Agents: GILLY, Richard, P. et al.; Richard P. Gilly Intellectual Property Law Offices, P.C., 1500 One Penn Center, 1617 John F. Kennedy Boulevard, Philadelphia, PA 19103-1815 (US).

(81) Designated States: AE, AL, AM, AT, AT (Utility model), AU (Petty patent), AZ, BA, BB, BG, BR, BY, CA, CH, CN, CU, CZ, CZ (Utility model), DE, DE (Utility model), DK, DK (Utility model), EE, ES, FI, FI (Utility model), GB, GD, GE, GH, GM, HR, HU, ID, IL, IN, IS, JP, KE, KG, KP, KR, KZ, LC, LK, LR, LS, LT, LU, LV, MD, MG, MK, MN, MW, MX, NO, NZ, PL, PT, RO, RU, SD, SE, SG, SI, SK, SK (Utility model), SL, TJ, TM, TR, TT, UA, UG, US, UZ, VN, YU, ZA, ZW, ARIPO patent (GH, GM, KE, LS, MW, SD, SL, SZ, TZ, UG, ZW), Eurasian patent (AM, AZ, BY, KG, KZ, MD, RU, TJ, TM), European patent (AT, BE, CH, CY, DE, DK, ES, FI, FR, GB, GR, IE, IT, LU, MC, NL, PT, SE), OAPI patent (BF, BJ, CF, CG, CI, CM, GA, GN, GW, ML, MR, NE, SN, TD, TG).

**Published**  
*With international search report.*  
*Before the expiration of the time limit for amending the claims and to be republished in the event of the receipt of amendments.*

(54) Title: APPARATUS AND METHOD FOR COLLECTING AND ANALYZING COMMUNICATIONS DATA

(57) Abstract

A method of monitoring data on a first communication line. Data is received from the first communication line (402) and a plurality of packets (406) are extracted (416) from the data. Statistics are then recursively generated (408), the statistics corresponding to the plurality of packets.

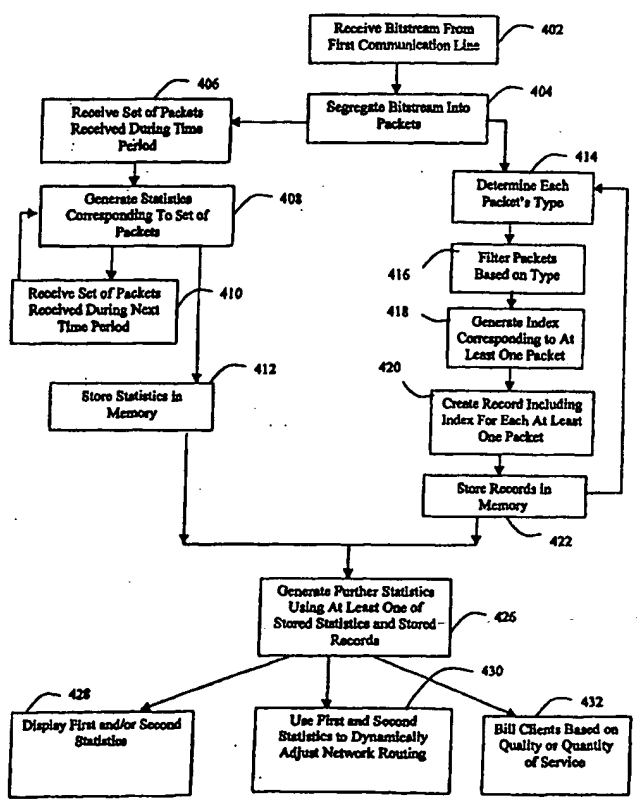

**FOR THE PURPOSES OF INFORMATION ONLY**

Codes used to identify States party to the PCT on the front pages of pamphlets publishing international applications under the PCT.

AL	Albania	ES	Spain	LS	Lesotho	SI	Slovenia
AM	Armenia	FI	Finland	LT	Lithuania	SK	Slovakia
AT	Austria	FR	France	LU	Luxembourg	SN	Senegal
AU	Australia	GA	Gabon	LV	Latvia	SZ	Swaziland
AZ	Azerbaijan	GB	United Kingdom	MC	Monaco	TD	Chad
BA	Bosnia and Herzegovina	GE	Georgia	MD	Republic of Moldova	TG	Togo
BB	Barbados	GH	Ghana	MG	Madagascar	TJ	Tajikistan
BE	Belgium	GN	Guinea	MK	The former Yugoslav Republic of Macedonia	TM	Turkmenistan
BF	Burkina Faso	GR	Greece			TR	Turkey
BG	Bulgaria	HU	Hungary	ML	Mali	TT	Trinidad and Tobago
BJ	Benin	IE	Ireland	MN	Mongolia	UA	Ukraine
BR	Brazil	IL	Israel	MR	Mauritania	UG	Uganda
BY	Belarus	IS	Iceland	MW	Malawi	US	United States of America
CA	Canada	IT	Italy	MX	Mexico	UZ	Uzbekistan
CF	Central African Republic	JP	Japan	NE	Niger	VN	Viet Nam
CG	Congo	KE	Kenya	NL	Netherlands	YU	Yugoslavia
CH	Switzerland	KG	Kyrgyzstan	NO	Norway	ZW	Zimbabwe
CI	Côte d'Ivoire	KP	Democratic People's Republic of Korea	NZ	New Zealand		
CM	Cameroon			PL	Poland		
CN	China	KR	Republic of Korea	PT	Portugal		
CU	Cuba	KZ	Kazakstan	RO	Romania		
CZ	Czech Republic	LC	Saint Lucia	RU	Russian Federation		
DE	Germany	LI	Liechtenstein	SD	Sudan		
DK	Denmark	LK	Sri Lanka	SE	Sweden		
EE	Estonia	LR	Liberia	SG	Singapore		

## APPARATUS AND METHOD FOR COLLECTING AND ANALYZING COMMUNICATIONS DATA

This application claims the benefit of priority under 35 U.S.C. § 119 from U.S. Provisional Patent Application Serial No. 60/109,718, filed November 24,  
5 1998, which is hereby incorporated by reference.

### TECHNICAL FIELD

The present invention relates generally to data communications, and, in particular, to a system and related method for collecting, analyzing, and monitoring data communications.

### BACKGROUND OF THE INVENTION

10 It is now routine for data and other information to be communicated to different points via a communications or data network. One example of such data networks includes multiple end-user computers which communicate with each other along the various paths comprising such networks. The complexity of such computer networks  
15 can range from simple peer-to-peer connection among a relatively small number of machines, to LANS, WANS and, of course, the global computer network known as the internet. The architecture of such networks varies widely, depending on the particular application, but most sophisticated networks make use of backbones, nodes, and computer servers supporting the transmission of data and information over such networks.

20 Companies and individuals are increasingly relying on such data networks not only for sending and receiving information, but for transacting business, and for any conceivable number of other activities involving the sending, receiving or viewing of information. The advent of the Internet and its continued development has only increased the demand for effective communication among companies, individuals, and other users of  
25 such networks.

This demand for sending and receiving data over such networks generates so-called "traffic", that is, a volume or "payload" of digitally-encoded information traversing appropriate paths on the network. Unfortunately, traffic across the network often leads to congestion or "trouble spots" at certain points or along certain paths of the

network. Such congestion may take the form of maddeningly slow transmission of data, or, at worst, a complete inability to send or receive needed information over such network. This problem is compounded by the fact that, under certain network architectures, the traffic generally proceeds only as quickly as its slowest link or pathway will allow.

5 Obviously, such traffic congestion is undesirable for any number of reasons. Users "stuck" in such traffic may blame the congestion on their network service providers, causing such providers to potentially lose business. Such network delays will also have a negative effect, both directly and indirectly, on productivity of the networks users.

10 One approach to relieving such network congestion or other network "trouble spots" is to obtain timely and accurate information about the congestion or trouble spot. Unfortunately, attempts of the current art to unravel the intricacies of computer networks and relieve the congestion suffer from various drawbacks and disadvantages. For example, network monitoring tools of the current art may be difficult  
15 to customize, and thus may lack the necessary tools to analyze network congestion or trouble spots. Such network "sniffers" are often limited to performing traffic dumps of certain specific protocols which, again, may fail to accurately describe or pinpoint the source of network congestion. In other words, most network monitors and "sniffers" of the current art are limited in their abilities to tabulate real-time data, or to record data over  
20 extended periods of time.

Network monitors of the current art generally intrude into the network in order to evaluate or estimate network performance. The reference "TCP/IP Illustrated, Volume I – The Protocols," Chapters 7 and 8, available from Addison-Wesley Publishing Co., 1994, describes one such technique. To estimate round-trip times for "packets" of  
25 information in the internet, the network monitor injects additional packets into the network and follows the travel of such additional packets. Thus, the very process of determining network performance itself further degrades performance by adding additional packets of information to the traffic.

Not only is the above-described method intrusive, but it is generally  
30 inaccurate as well. In particular, one-way times are evaluated by generally dividing the

round-trip delay of the test packet by two; however, half of a round-trip time is generally not equivalent to a one-way delay, in part based on asymmetries (discussed below) in the network. To compensate for this inaccuracy, certain teachings of the current art inject test packets more frequently into the network, a solution which may further degrade the performance of the network which is being tested or monitored.

Network performance may be further enhanced if network traffic flow or network bandwidth dimensioning could be more accurately modeled. In particular, traffic does not necessarily flow symmetrically across a given network path. This is especially true when the path terminates in an end user on an internet connection. Such a path is asymmetric in that the end-user normally downloads more payload or traffic than he or she uploads. Network monitors of the current art generally do not detect or model such asymmetries, with the result that greater network resources are devoted to particular routes than may otherwise be required. This costs additional money and wastes computer resources.

There is thus a need to improve network performance and relieve network traffic congestion. There is a further need for tools which do not intrude upon the traffic flow, which can be adapted to analyze different traffic parameters or types of "packets," and which collect and tabulate required statistics quickly and accurately.

With the increasing use of computer data networks, companies and individuals are increasingly interested in collecting, filtering, or "profiling" data about the users or their traffic on such networks. Marketing enterprises or other sales organizations may be particularly fascinated by demographic or other data which can be gleaned by accurate recording and analysis of network traffic. Unfortunately, many internet advertisers obtain customer profiles by requiring the users to fill out forms and questionnaires. Advertisers miss out on most of this customer information because customers often do not want to be bothered with answering such questions. There is thus a need to obtain customer "profiles" in a less intrusive manner.

The expanding use of networks has likewise expanded the possibilities of "hackers" or other damaging intruders performing mischief or even criminal activities in proprietary or protected networks. As such, a system which can determine the origin of

security breaches would be valuable to enforcement agencies, such as the FBI, to stem the tide of computer-related crimes and misdemeanors. The current art, again, generally fails to analyze, tabulate, monitor, or record the flow of data over a network in an optimal way to facilitate security activities.

5           Companies or individuals charged with monitoring networks not only need to obtain vast amounts of information and statistics in a timely manner, but they also need to view such data quickly, easily, and in an understandable format. Again, current art solutions are often limited to providing "dumps", often chronologically, with inadequate statistical compilations or graphical representations of such data. It is thus desirable not  
10 only to compile network traffic information, but to perform certain commonly needed calculations, and to graphically represent such calculations in a user-friendly and flexible format.

To overcome the shortcomings of conventional data communication monitoring methods and systems, a new method of monitoring a communication line is  
15 provided. An object of the present invention is to provide a network monitor for collecting and analyzing communication data. Another object is to provide a method for collecting and analyzing communication data.

#### SUMMARY OF THE INVENTION

To achieve these and other objects, and in view of its purposes, the present  
20 invention provides a method for monitoring data on a first communication line. Data is received from the first communication line and a plurality of packets are extracted from the data. Statistics are then recursively generated, the statistics corresponding to the plurality of packets.

It is to be understood that both the foregoing general description and the  
25 following detailed description are exemplary, but are not restrictive, of the invention.

#### BRIEF DESCRIPTION OF THE DRAWING

The invention is best understood from the following detailed description when read in connection with the accompanying drawing. It is emphasized that, according to common practice, the various features of the drawing are not to scale. On the contrary,

the dimensions of the various features are arbitrarily expanded or reduced for clarity.

Included in the drawing are the following figures:

Fig. 1 shows a network monitor according to the present invention coupled to a communication line;

5 Fig. 2 illustrates an exemplary protocol hierarchy;

Fig. 3 is a block diagram of an exemplary network monitor according to the present invention;

Fig. 4 is a flow chart illustrating an exemplary method of monitoring a communication line according to the present invention;

10 Fig. 5 is a data flow diagram illustrating the many permutations of data collection and analysis methods of a network monitor according to the present invention;

Fig. 6 is a flow chart illustrating a method for identifying troubled servers;

Fig. 7 shows a network using network monitors according to the present invention coupled to two separate communication lines in a network;

15 Fig. 8 is a flow chart illustrating a method for determining transmission delay;

Fig. 9A is a flow chart illustrating operation of a host computer for synchronizing with an interface computer;

20 Fig. 9B is a flow chart illustrating operation of an interface computer for synchronizing with a host computer; and

Figs. 10-28 are screen displays illustrating a user interface for receiving monitoring parameters and illustrating methods of displaying and providing communication analysis information.

#### DETAILED DESCRIPTION OF THE INVENTION

25 Referring now to the drawing, in which like reference numerals refer to like elements throughout, Fig. 1 illustrates an exemplary network monitor 102 according to the present invention which is coupled to an exemplary network N1 106 via a first

communication line 104. The network monitor 102 receives (monitors) data communications (traffic) on communication line 104 and provides real-time metrics or statistics of the data traffic on the communication line 104.

The communication line 104 may use a single data link layer protocol to transport traffic of a multitude of different higher hierarchical protocol layer protocols. One such hierarchical protocol structure 200 is illustrated in Fig. 2. The data link layer protocol 202, Ethernet in this exemplary case, of traffic between the network N1 106 and the router 108 may include encapsulated IPX, IP, ARP, or other network layer 204 traffic. The IP traffic may include encapsulated UDP, TCP, ICMP or other transport layer 206 traffic. The TCP traffic may include encapsulated Web, FTP, Domain Name Service, or other application layer 208 traffic.

The network monitor 102 according to the present invention includes hardware and software (discussed below) which collects and analyzes network traffic in such a way that it can generate a variety of real-time statistics on such traffic at one or multiple protocol layers. The real-time statistics generated by network monitor 102 enable quality and quantity of service analysis, billing based on quality of service and quantity of service, dynamic network resource allocation and planning, customer profiling based on data content, network security analysis, and session playback. Exemplary statistics include byte counts, bit counts, one-way or roundtrip delays, response times, retransmitted bytes, originating bytes per host, terminating bytes per host, originating-terminating host pair counts, web abort rates, throughput, goodput, and percent retransmitted bytes due to delays or losses. These statistics may selectively be provided based on traffic on the first communication line 104 on one or multiple protocol layers between the data link layer and the application layer.

Operation of an exemplary network monitor 302 shown in Fig. 3 is described with reference to the flow chart in Fig. 4. The network monitor 302 includes a first network interface 304 coupled to a first communication line 308 by a first connection 312 and a second network interface 306 coupled to a second communication line 310 by a second connection 314. The first interface 304 receives first data (a bitstream) from the first communication line 308 (step 402) and the bitstream is then segregated into packets (step



404). The term segregate is used herein to mean that previously defined packets are being extracted from the bitstream. The bitstream may be segregated into packets by either the interface 304 or by the host computer 316. The packets are stored in memory 318 which is hierarchical in this embodiment and includes a short-term memory 320 and at least one longer-term memory 322. A processor and query engine 316, optionally controlled by a user interface 324, then processes the packets as described below with reference to Fig. 4.

In an exemplary embodiment, the network monitor 302 is coupled to the first communication line 308 in a non-intrusive manner. That is, it does not directly hinder the flow of traffic on the communication line. The network monitor 302 may be coupled to the communication line 308, for example, by plugging the first connection 312 into a port or jack on a switch or router, by breaking the communication line 308 and installing a Y-connector to which the first connection 312 is coupled, by connecting the first connection to a hub, using an optical splitter, or by connecting the network monitor 302 to a monitoring jack in a central office.

Processor and query engine 316 converts the packets into records and stores the records in memory (steps 414-422). Processor and query engine 316 includes suitable programming to generate statistics corresponding to the packets (steps 406-412). Although the generation of statistics for the packets may be accomplished in a variety of ways, one preferred approach processes a set of packets received over a predetermined timer interval or "sampling time" (step 406) to generate corresponding statistics (step 408). The processing is then repeated in a recursive fashion to successive sets of packets received during successive time periods (step 410). During such processing, suitable programming stores the generated statistics in memory at appropriate intervals of time, such intervals preferably on the same order as the time intervals corresponding to the sets of packets.

The conversion of the packets into records permits a wide variety of further statistics to be generated as now described. The records are generated by first determining the type of each packet (step 414) and then filtering the packets (step 416) based on their determined types. An index is generated (step 418) for each packet and the packet is then converted into an indexed record (step 420) and stored in memory (step 422). Further

statistics are then generated (step 426) using the statistics previously generated for the packets and records are then provided to one or more applications such as a display device (step 428), a router for dynamically adjusting network routing based on the further statistics (step 430), and a billing service for billing clients based on quality or quantity of  
 5 service as determined based on the generated statistics (step 432).

Application of the process of Fig. 4 is now described for an Ethernet communication line including encapsulated IP packets which encapsulate TCP packets which encapsulate web traffic (See Fig. 2). The Ethernet bitstream is received from the communication line (step 402) and is segregated into packets (step 404). The packets are  
 10 divided into sets, each set including packets received during one of successive one-second time periods (exemplary time period) (step 406). The number of bits received during each one-second time period (exemplary statistic) is calculated (step 408). Successive statistics are generated for successive time periods by receiving the next set of packets corresponding to the next one-second time period (step 412) and then calculating the  
 15 number of bits in those packets (step 408). The bit counts for each one-second time interval are stored in memory (step 412) as they are generated.

A type (e.g. IP, ARP, ...) of each packet is determined (step 414). If a user only wishes to analyze traffic of IP packets, the packets are filtered to pass only the IP packets (step 416). The time when the network monitor received each IP packet is used as an  
 20 index for the each respective IP packet (418). An indexed record is then generated (step 420) for each IP packet and is stored in memory (step 422). An exemplary record having the index as a first field F1 and the packet as a second field F2 is illustrated below.

F1: Index (time of receipt)	F2: Packet or portion of packet
-----------------------------	---------------------------------

25 In addition to the filtering (step 416) only passing IP packets, the filter may also be used to pass only a portion of the packet, such as only the IP portion, by truncating the Ethernet overhead portion so the record above contains only the IP portion in the second field F2. Alternatively, the record may include a plurality of fields, each corresponding to

a portion of the IP packet such as a source address or destination address, and filtering may be performed based on any one or more of the plurality of fields.

Any number of statistics can be generated from the stored records alone, or in combination with statistics for the packets generated in steps 46-412. In this example, a further statistic known to the art of interest includes the ratio of the number of bits in IP packets received to the number of bits in all packets received for each successive minute (step 426). The calculation of this statistic is facilitated according to the present invention, because the stored packets are already all IP packets and are indexed by time of receipt. As such, the calculation is performed by sorting the records by index, reading the set of records for each successive minute, and adding the number of bits in each set of records. The number of bits in all packets per minute may be calculated by summing the previously calculated bit counts generated on a per second basis in groups of sixty (thereby equaling one minute). Thus, the further statistic is generated using both the stored records and the stored statistics, which reduces the number of additional calculations needed and the time to generate such further statistic.

A specific example of the filtering and storing methods performed by a network monitor according to the present invention was described above with regard to Fig. 4. The flexibility of data collection and analysis methods of a network monitor 500 according to the present invention are described below with regard to the data flow diagram of Fig 5.

An incoming bitstream is packetized by a packetizer 502. Decoding of the bitstream may be automatically performed for known protocols or may be performed according to user-specified parameters for custom or proprietary protocols. For example, if a new data link layer protocol is introduced, network monitor 500 includes suitable programming to respond to user-defined protocols, entered using the user interface 520. The inventive network monitor 500 thus recognizes packet structures of the new protocol to packetize an incoming bitstream. The network monitor could then perform its data collection and analysis methods through the higher protocol layers. This flexibility is not limited to the data link layer. In other words, the network monitor 500 according to the present invention is able to collect and analyze data communications for custom protocols at other protocol layers.

The packets may be directly stored into the short-term memory 510 using path A. This is useful for storing all data received from the communication line. The short-term memory 508 may periodically transfer data to a long-term memory 510 to prevent overflow. Although illustrated as having only a single short-term memory 508 and a single long-term memory 510, the teachings of the present invention are applicable to other hierarchical memory structures including a plurality of memory devices. For example, the memory may include a random access memory (RAM), a disk memory, and a tape memory. As the RAM fills, data is transferred to the disk memory. As the disk memory fills, data is transferred to the tape memory. As the tape memory fills, tapes are replaced for continuous or long-term data storage for archival purposes, for example. As indicated by the double arrow to the short-term memory 508 and between the memories 508, 510, data stored in the memories may later be retrieved for analysis or for one of the applications 522-530 discussed below.

Storing all packets directly into memory may be desired for security applications 528. For example, the network monitor may be programmed to store all communications for a period of 1 week and then overwrite the oldest stored data. If a breach in security is detected within a week of its occurrence, the stored data may be analyzed by the network monitor to determine the source and extent of the breach.

The packetized data may alternatively be provided by the packetizer 502 to the index generator 504. The index generator 504 generates an index corresponding to one or more of the received packets. Examples of an index corresponding to a packet include a time stamp to indicate the time it was received by the network monitor, the type of packet (protocol and/or layer), the size of packet, a packet number (1, 2, 3, ...), an interface number, an application, and an associated session. Record generator 506 receives the packets and the generated index and generates a record including the generated index. Alternatively, the record generator 506 may combine the received packet and index with an existing record previously stored in memory 508, 510. The record generator may also receive a packet directly via path C and generate an unindexed record including the packet or may combine the packet into an existing record previously stored in memory 508, 510.

For example, a single record may be generated corresponding to an ATM session. When a first cell (a fixed size packet) corresponding to the ATM session is received, it may be indexed and an indexed record may be generated and stored in the memory 508, 510. The index may be an identifier of the ATM session, for example. When further cells  
5 corresponding to the ATM session are received, not necessarily in order, the record generator 506 may directly receive these cells via path C, read the previously stored indexed record from memory 508, 510, and then combine the newly received cell into the indexed record. In addition to simply combining packets belonging to a common ATM session in a common record, the record generator 506 may also orient the received ATM  
10 cells within the record in their correct order.

The record/packet type identifier 512 receives packets or records from either the record generator 506 or from the memory 508 and then characterizes the received packets or records by identifying its corresponding "type" or "property". The type or property of a packet or record is a versatile identifier and may be programmed via the user interface 520.  
15 Examples of packet or record types or properties include the number of corresponding bits or bytes, its protocol layer, its protocol type at a particular protocol layer, a source address, a destination address, an end-user ID, and an application ID. The records or packets are then filtered in the packet type filter 516 based on the property or type identified by the record/packet type identifier 512. The filtered records or packets are then indexed,  
20 indexed and turned into records, or directly stored into memory 508, 510.

The time period filter 514 receives records or packets from the record generator or the memory 508, 510, and filters them based on the time they were received from the communication line by the network monitor. The records or packets are then segregated into groups corresponding to packets received by the network monitor during respective  
25 successive time periods. The statistic generator 518 then generates statistics for each of the successive time periods corresponding to packets received during each respective successive time period.

The filtered packets and the generated statistics may be stored in memory. The paths between the functional blocks in Fig. 5 illustrate that the contents of memory may  
30 then again be used to perform further filtering or statistic generation. Thus, a network

monitor according to the present invention may recursively collect and analyze data by generating statistics based on previously generated statistics or stored packets.

In addition to programming the network monitor for a custom protocol as described above, the user interface 520 may also define the operating parameters of the functional blocks within the network monitor. For example, a user may specify the index  
5 to be used by the index generator 504, the time period to be used by the time period filter 514, and the statistics to be generated by the statistic generator 518 for each of the successive time periods.

The collected data and the corresponding analysis generated by the network  
10 monitor 500 may be provided to one or more applications 522-530. For example, a display device 522 may display statistics, records or packets responsive to user selection as further described below with regard to the display screens in Figs. 10-28.

The statistics generated by the network monitor 500 may be provided to a network administrator or router 524 to allow for dynamic routing of communications and network  
15 bandwidth management, also known as "yield management", on a network responsive to statistics corresponding to network performance. It is readily appreciated that, by measuring one-way delays and by providing traffic statistics on a protocol-by-protocol basis at different protocol layers, a network monitor according to the present invention can identify these asymmetries by quantifying traffic flows to allow a network administrator to  
20 properly size network resources according to the measured flows.

Communication networks can be optimized at the service layer because the network monitor according to the present invention includes suitable programming to analyze traffic flows at any protocol layer. Although different services may have different service requirements, these services are often integrated in a single communication  
25 network. Nonetheless, services such as real-time multimedia, voice over IP, data, and Intranet may each have unique network service requirements. For example, for voice over IP, due to low tolerances in voice transmissions degradation, a lower quality of service including delay or loss of data may not be tolerated. In contrast, data transmission can proceed in a lossy environment due to error recovery by retransmission. An exemplary

router 524 is configured to route traffic corresponding to different services differently depending on their service requirements.

The network monitor according to the present invention includes programmed features which identify flows corresponding to each individual service and/or user and provide for analysis of interactions with different services. This information may be used by a router, for example, to make real-time or non-real-time decisions on optimizing network topologies, routes, or service segregation, etc. to achieve an optimal configuration suitable for providing each and every service with its own unique quality of service requirement.

A billing system 526 may be configured to receive quality and/or quantity of service statistics corresponding to different services and different hosts and bill clients accordingly. This allows clients to be billed based on these statistics rather than providing flat rate billing for previously unmeasured service. For example, a client may use her unlimited Internet service for voice over IP communication. According to the present invention, the network monitor 500 may generate statistics for a particular client on the number, duration, and destination of voice over IP calls. The statistics are then converted to billing information by the billing system 526 and the client is billed accordingly. Thus, an Internet subscriber that uses the Internet for voice over IP calls, may now be billed according to the quantity, duration, and destination of calls as is done for non-Internet telephone service. Clients may similarly be billed based on a number of e-commerce transactions, a number of stock trades, a number of requests for real-time stock quotes, and other transactions. Alternatively, clients may have service contracts including different billing rates depending on a quality of service provided and may be billed accordingly. A network monitor may also be used to ensure compliance with service contracts which guarantee minimum service standards or service level agreements.

As described above, the collected data may be used for security 528 to identify breaches in security, to identify improper network use or illegal activity. For example, packets may be filtered to identify particular files which have been FTP'd to a server, to identify who telnetted (logged onto) a particular machine or server, and to see what they typed once logged on.

Statistics from a network monitor may be correspond to a user or a group of users for profiling the user or group. Much Internet advertising is directed to customers based on a customer profile generated by asking a user to answer a few questions. A network monitor according to the present invention can filter each received packet based on its contents to build individual customer profiles. For example, a node which monitors the Philadelphia customer base may look at every packet from every user before it enters the Internet. Also, the returned traffic to these users can be analyzed by looking (filtering) for specific text within the packets or for the web sites visited by the user. A profile per user or group of users may then be generated based on the filtered data to target content to the user which will be of interest to the user such as targeted email. The method described above for filtering may similarly be used by law enforcement or security officials to monitor communications to detect unlawful activity or to monitor activity of selected users.

The network monitor may also be used to provide data to a playback device 530 to playback client sessions which were monitored from the communications line. All received packets may be recorded and then filtered based on a particular session. The session may be identified based on information included in the packets themselves or based on session information received in special packets or channels such as SDR (session directory protocol). The packets corresponding to the session may then be played back in a fashion originally presented to the user. This method may be used to replay all web activity of a user or of voice over IP conversations.

The network monitor may be configured by a user to monitor communication lines that transport traffic using a proprietary or custom protocol. Along with a suitable physical layer interface between the network monitor and the communication line, a user may enter proprietary protocol parameters using the user interface. The parameters define the structure of packets within the bitstream transported on the communication line for the network monitor to segregate the packets from the bitstream. Additional parameters may also define fields within a packet so the network monitor could be configured with custom queries to provide statistics based on the content of these packet fields. The network



monitor may similarly be programmed to receive and analyze data corresponding to custom protocols at layers higher than the link layer.

In an exemplary network, the data transmission protocol provides for each packet to include a time stamp field. Packets transmitted from a source to a destination include a  
5 time stamp value in the time stamp field indicating a time of transmission by the source. When the packet is received at the destination, the destination can compute the one-way transmission duration or delay from the source to the destination by subtracting the time stamp value from a current time value. This protocol allows for simpler one-way  
10 transmission delay and quality of service measurements by eliminating the need for communication between network monitors to match packet pairs at separate network monitors.

For a network including many separate intermediate transmission paths between the source and the destination, the one-way end-to-end transmission duration information does not provide information regarding a particular bottleneck somewhere between the  
15 source and destination. For improved bottleneck diagnosis, rather than only calculate end-to-end delays, a network monitor according to the present invention can be coupled to one of the intermediate separate transmission paths between the source and destination. The network monitor can receive the time stamp value from a packet traversing the network from the source to the destination. The time stamp value may be subtracted to the current  
20 time at time of receipt of the packet by the network monitor to determine an intermediate duration value. One or more intermediately spaced monitors may be used as described above to locate the bottleneck in a network. In an exemplary embodiment each of the source, destination, and network monitor include a GPS (global positioning satellite) interface for receiving the current time used to calculate the transmission duration.

25 One of the metrics that a network monitor according to the present invention can provide is an indication of the number of aborted connections for a particular source-destination pair, for a particular source or destination, and information on the ration of aborted connections to total connections for a particular source or destination. An exemplary method of identifying troubled TCP (transmission control protocol) servers is  
30 described with regard to the flow chart 600 in Fig. 6.

As known to those skilled in the art, a TCP session is normally opened by the client and is then closed by the server when it has no more data to send to the client. If a TCP session is closed by the client, this indicates that the session is being terminated prematurely. Using the web as an example, a client (user using browser) may close the session for reasons including simply changing one's mind regarding the need for the desired data or due to impatience due to delay in receiving desired data.

The network monitor receives a packet from a communication line (step 602) and identifies whether the packet belongs to a TCP session (step 604). The network monitor may identify whether the packet is a TCP packet by identifying and decoding a protocol field in the packet which identifies which of several transport layer protocols the packet belongs to. Once a packet is identified as TCP, the TCP client and TCP server are identified (step 606). The packet is then examined to determine whether it opens or is initiating the TCP connection (step 608). If the packet is the opening or initiating packet of a TCP session, a count of the total number of TCP sessions for the previously identified (in step 606) TCP server is incremented (step 610).

If the packet is not an opening packet, the network monitor next determines whether the packet is closing the TCP connection (step 612). If not, the network monitor gets the next packet (step 602). Otherwise, the network monitor determines (step 614) whether the connection is being closed by the server, by examining the FIN bit for example, or whether the connection is being closed by the client. Closure by the server indicates normal termination of the session and the network monitor gets the next packet (step 602). Closure by other than the server indicated premature termination of the session and a premature closure count corresponding to the particular server is incremented (step 616). The ratio of premature closures to the total TCP sessions of the particular server is calculated (step 620) and compared to a predetermined threshold value (step 622). If the ratio of premature closures exceeds the threshold, the particular server is identified as a "troubled server" (step 624).

As known to those skilled in the art, in some networks all packets corresponding to a particular TCP session may not travel through the same communication line and therefore may not be detected by a single network monitor interface. A network monitor

can be placed in proximity to or on a server or client to “catch” all packets. Alternatively, multiple network monitor interfaces may be used as described above to store records corresponding to packets. The stored records may then be analyzed to determine which servers may be “troubled”. In an exemplary embodiment, remote network monitors each  
5 look for FIN packets, using a filter, for example, and upon detecting a FIN packet they send a message including the contents of the FIN packet to a central monitor that makes the “troubled server” determination.

Although the teachings regarding measuring aborted connections and identifying troubled servers are described above with regard to TCP sessions, these teachings are  
10 generally applicable to other protocols and to other protocol layers and are not limited to identifying troubled TCP servers. For example, in another protocol, a session may be both opened and closed by the same node, whether it be the client or the server. In addition, the session payloads may be transmitted in separate packets from or on separate communication links from the session control messages.

15 In a further alternative embodiment shown in Fig. 7, a system 701 for monitoring communications according to the present invention may include one or more network monitors each coupled to respective communication lines in a network as shown in Fig. 7. First, second, and third network monitor 700, 710, 720 are coupled to the first, second, and third communication lines 702, 712, 722, respectively. Each network monitor 700, 710,  
20 720 collects and analyzes data received from its respective communications line as described above with regard to the data flow diagram in Fig. 5.

In addition to providing independent data collection and analysis, a system including a plurality of network monitors 700, 710, 730 may correlate data received at the different network monitors to provide improved network performance analysis. For  
25 example, one-way delay may be calculated for data traveling from the first communication line 702 to the second communication line 712.

An exemplary method of calculating the one-way delay is illustrated by the flow chart in Fig. 8. Generally, the “same” packet is identified at two separate network monitors and the difference in time between when it was received by each monitor is used

to calculate the one-way delay. The "same" packet is identified by zeroing out portions of the packet that change between the separate network monitors.

Each of the first and second network monitors 700, 710 receives data (step 802, 806) from its respective communication line 702, 712. The packetizer 502 segregates the received data into packets (steps 803, 807) and each the index generator (504) associates  
5 the time of receipt (time stamp) of each packet with each packet. The record generator 506 generates a record including the time stamp of corresponding to each packet and a unique portion of the data packet (UPDP) and stores the record in memory 508, 510 (steps 804, 808).

10 The UPDP is a portion of the received packet that makes the data unit uniquely identifiable. For example, for an Ethernet communications line and an IP payload, the Ethernet header is removed from the packet, the IP ttl and checksum fields are zeroed, and the IP header and the 20 succeeding bytes are saved and incorporated by the record generator 506 into a UPDP record. The UPDP may be different for different protocols and  
15 may be programmed using the user interface.

The UPDP records of the first network monitor 700 are compared to the UPDP records of the second network monitor 710 to match pairs of UPDPs (step 810). The first and second network monitors may communicate via a communication link 730. The communication link 730 may be implemented by communication of the network monitors  
20 through the network they are monitoring (in-band). Alternatively, the communication link 730 may be implemented by communication external to the network over a telephone line, a radio connection, or a satellite connection, for example (out-of-band).

For each matched pair of UPDPs, the corresponding time stamp  $ts_2$  from the second network monitor is subtracted from the corresponding time stamp  $ts_1$  from the first  
25 network monitor (step 812). This time difference  $ts_1 - ts_2$  represents the duration for the data corresponding to the UPDP to travel from the second network monitor 710 to the first network monitor 700. By calculating the UPDP, the transmission duration of a certain payload between first and second communication lines 702, 712 using the same or

different communication protocols may be determined according to the method described above.

In an exemplary embodiment, the time difference  $ts1-ts2$  is normalized (steps 814, 816) to account for the delay of the first communication line 702. The delay is normalized  
5 by subtracting the delay  $xmit\_delay$  for the packet corresponding to the UPDP to traverse the first communication line from the time difference as illustrated by the equation below:

$$\text{Normalized Network Delay} = (ts1-ts2) - (\text{link\_speed}/\text{packet\_length})$$

where  $link\_speed$  is the transmission rate on the first communication line 712, and  $packet\_length$  is the length of the packet on the first communication line which contained  
10 the UPDP. The calculated network delay may include components due to queuing delay and to transmission delay. As illustrated by the data flow diagram in Fig. 5, the statistic generator 518 can receive the packet for which is UPDP record is to be generated, the statistic generator 518 calculates the number of bits in the packet and provide this statistic to the record generator for incorporation into the UPDP record for use in a normalization  
15 calculation. Round-trip times may be estimated by similarly calculating the delay from the first to the second network monitor and adding this delay to the delay between from the second to the first network monitor.

The accuracy of the calculated transmission delay depends on the synchronization of the time clocks of the first and second network monitors 700, 710. The network  
20 monitors may communicate via communication line 730 to synchronize their respective clocks. In an exemplary embodiment, the network monitors are synchronized by receiving a time signal from a common time source 740. In an exemplary embodiment, the transmission delay is generated at a level of accuracy less than 10 microseconds, that is, the difference between the calculated delay and the actual delay is less than 10  
25 microseconds. In a preferred embodiment, the common time source 740 is a system of global satellites such as the global positional satellites (GPS) and each network monitor 700, 710 includes a receiver for receiving a time signal from one or more global satellites. When the two communication lines to be monitored are proximate to each other, one of

the first and second network monitors 700, 710 may include a master GPS receiver and the other may include a slave GPS receiver coupled to the master.

An exemplary network monitor is implemented with a host computer having an interface computer on a network interface card (NIC) coupled to the communication line it is monitoring. As described above, data received by the NIC may be processed before being sent to the host computer. Also as described above, the network monitor may use the time of receipt of data from the communication line for generating network communication statistics or metrics. In order to accurately record the time when data is received from the communication line, the interface computer associates a time of receipt with the data (time stamps the data). By having the interface computer rather than the host computer time stamp the data, inaccuracies in the time of receipt due to a delay in transferring data from the interface computer to the host computer are reduced or eliminated.

In an exemplary embodiment, the interface computer includes an interface clock and the host computer has a host clock. The host clock and the interface clock are synchronized so the host computer can use the time stamp to accurately generate statistics corresponding to the received data. In an exemplary embodiment, the interface clock is implemented as a counter. As each packet is received from the communications line, the current value of the counter is associated with that packet. The packet is later transferred to the host computer with the counter value. The host computer includes a host clock synchronized with an absolute time reference. As described above, the absolute time reference may be provided by a global positioning satellite.

The host clock and the interface clock are synchronized by correlating the counter values associated with each packet by the interface computer with the absolute time reference. The method of synchronizing the interface clock with the host clock is described with reference to the flow charts in Figs. 9A and 9B with regard to the host computer and the interface computer, respectively. Generally, the host computer periodically requests the value of the interface clock counter from the interface computer and uses this value to correlate the counter to the host clock.

Referring to Figs. 9A and 9B, if the host computer has received a set of packets from the interface computer (step 902), the host computer proceeds to request the counter value (step 906) from the interface computer by sending a "get counter" message to the interface computer. In an exemplary embodiment, the interface computer stores a set of packets in a memory of the host computer by a direct memory access (DMA) operation and then interrupts the host computer to indicate the transfer of packets. If the host computer has not received a set of packets, the host computer waits for packets for a timeout period (step 904), after which it requests the counter value (step 906). The host computer records the host clock's time (step 906) when it requests the interface counter value.

When the interface computer receives a "get counter" message (step 920) from the host computer, the interface computer then determines (step 922) whether it is currently idle or whether it is receiving data from the communication line. If not idle, the interface computer sends (step 924) a "try again" message to the host computer. If idle, the interface computer then reads the counter value and subtracts a precomputed interrupt service time (step 926) to generate an adjusted counter value. The interface computer then sends (step 928) the adjusted counter value to the host computer.

The precomputed interrupt service time corresponds to the duration of time between when the interface computer receives the counter request from the host to when the interface computer provides the host computer with the adjusted counter value. The precomputed interrupt service time may be determined experimentally using a logic analyzer, for example to measure the duration of time between when the interface receives the request for the counter until the interface provides the counter value. To match the experimental delay measurements to the delay during normal operation, the experimental request is provided to the interface when the interface is known to be idle and the interface only services a request during normal operation when idle. As known to those skilled in the art, the response time of the interface computer may be taken repeatedly to generate an average service time for use during operation.

Upon receipt of the counter value, the host computer computes (step 912) an estimate of the relative frequency of the interface clock counter to the host computer clock.

The relative frequency may be used to correlating counter values associated with packets received from the interface computer until the next execution of the synchronization routine. In an exemplary embodiment, the host computer subtracts a host interrupt service time from the time recorded in step 906 before computing the relative frequency to  
5 account for the delay between the time when the host receives the count from the interface to the time when the host computes the relative frequency.

In an exemplary embodiment, a multiple network interfaces each coupled to a respective communication line are implemented as a single unit and share a common clock. Thus, synchronization with only the common clock synchronizes the host clock  
10 with the time stamps associated with data received from any of the respective communication lines.

Figs. 10-28 are exemplary screen displays illustrating a graphical user interface (GUI) for displaying data collected and analyzed by a network monitor and for controlling data analysis by a network monitor according to the present invention. The display in Fig.  
15 10 includes a tables frame 1010, a second frame 1030, and a buttons frame 1050. The tables frame 1010 includes a first portion 1011 with selectable boxes for user selection and text input boxes and a second portion 1012 with tables of statistics corresponding to received data. The tables 1023 which appear below the selectable buttons, boxes and fields include entries corresponding to the particular data being analyzed. The plots frame  
20 1030 includes plots 1032, 1034 illustrating statistics corresponding to received data. The buttons frame 1050 includes a set of user-configurable buttons.

The text input boxes and the selectable boxes in the first portion 1011 of the tables frame 1010 may optionally be fixed to prevent user selection of the options and prevent user entry in the text boxes. The functions associated with the options and boxes  
25 displayed in Fig. 10 are described below:

1. **Start:** The start field 1013 specifies the beginning time from which the traffic is analyzed and its results are displayed in the GUI.
2. **Stop:** The Stop field 1014 specifies the ending time to which the traffic is analyzed and its results are displayed in the GUI. Thus the Start/Stop fields  
30 1013, 1014 specify the time between which the traffic has been analyzed and



presented to the user via the GUI. The contents of the Start and Stop fields 1013, 1014 may be displayed in multiple formats. For example, the contents are shown in a date format in Fig. 10. Alternatively, the contents may be displayed as +/- hours to indicate that a time relative to the current time, the term "now" may be used to represent the current time, or the term "never" may be used to represent that the data should be continuously updated.

3. **Window:** The Window field 1015 indicates the time intervals at which to compute values to be plotted in the second frame 1030. For example, if a user enters "1" as the Window field, then the values in the plot field are plotted every second. The user may enter the values in the Window field in using units as appropriate to indicate the resolution of the plots (e.g. 1s, 1ms, 100us, ...to indicate a time resolution if the unit of the horizontal scale is time). An empty Window field 1015 indicates that the resolution on the horizontal scale should be automatically set.
4. **Top N:** The Top N field 1016 specifies the maximum number of entries for the tables 1023 which appear in the second portion 1012 of the tables frame 1010. If Top N is 10, then the table 1023 will include 10 rows sorted by a particular column value in descending order. If TopN is -10, then the table 1023 will include 10 rows sorted by a particular column value in ascending order (i.e. this becomes the notion of BottomN).
5. **Filter:** The Filter window 1017 describes a filter to be applied to the data to be displayed. For example, Filter could be "protocol IEEE802.3" to display results for packets with link layer protocol IEEE802.3. For data previously filtered to show only IP traffic, a Filter of "host 10.0.0.1" would display results for IP traffic where either the source or destination host was 10.0.0.1. Various complex filters are also possible.
6. **Do DNS:** The Do DNS checkbox 1018 converts entries in the tables 1023 from a numerical representation to a textual representation. For example, in IP a numerical representation (the IP address) is used to identify a host. A DNS

(Domain Name Server) may contain a mapping from this numerical representation of the IP address to a textual representation. For example, the IP address 10.0.0.1 may be converted to the textual representation foo.niksun.com when the Do DNS checkbox is checked. For protocols other than DNS the label given to the checkbox will vary accordingly with an equivalent functionality.

7. **Help:** The help buttons 1019 next to each field when selected cause display of context-sensitive assistance. For example, if the help button next to Filter 1017 is selected, a help window for Filters would pop up.
8. **Refresh:** The Refresh button 1020 refreshes the contents of all frames.
9. **Forward and Backward Buttons:** The forward 1021 and backward 1022 buttons at the top of first portion 1011 of the tables frame 1010 function similar to the "Forward" and "Back" buttons of a browser with the added feature of keeping the contents of all frames aligned. In contrast, clicking the "Forward" and "Back" buttons of a browser causes forward of backward movements on a frame by frame basis hence loosing correspondence between the various frames.

The plots frame 1030 includes plots 1032, 1034 , text input boxes and selectable boxes and buttons. The text input boxes and the selectable boxes may optionally be fixed to prevent user selection of the options and prevent user entry in the text boxes. The functions associated with the options and boxes displayed in the plots frame 1030 of Fig. 10 are described below:

1. **Update Tables and Plots:** This button 1036 updates the tables and frames in a coordinated manner. For example, if a user zooms in by selecting a portion of the plot with a mouse, then clicking this button 1036 would update the plots and tables for the selected time-range that was zoomed into.
2. **Byte/Packet Counts (and Bit/Packet Rates) (and Utilization):** This button 1037 changes between one of three options upon selection: "Byte/Packet

Counts”, “Bit/Packet Rates”, and “Utilization”. The plots also change from Byte/Package Counts over a certain window, to Bit and Packet Rates (i.e. number of bits or packets per second), to Utilization accordingly. In an exemplary embodiment, the byte plot displays normalized values relative to the link speed (i.e. bit rate divided by link or channel or virtual circuit capacity in bits per second).

3. **Toggle Parent Plot:** This button 1038 toggles the line on the plots as described below.
4. **Toggle Plot of Average:** Selection of the Toggle Plot of Average button 1039 toggles whether the average value (not shown) of the y-axis of the plots is displayed.
5. **Play/Forward/Stop/Fast Forward/Rewind/Fast Rewind/Pause Buttons:** These buttons 1040 control the playing of the plots on the screen to allow the plots to be updated over time and to scroll with time. The tables 1023 in the table frame 1010 are be updated to match the plots 1032, 1034.
6. **Top Plot:** The top plot 1032 shown in Fig. 10 is a Link Level Bit Rate plot in bytes/second.
7. **Bottom Plot:** The bottom plot 1034 in Fig. 10 is a Link Level Packet Rate blot in packets/second.

The table 1023 in the tables frame 1010 is automatically generated based upon protocols found to be active in the interval specified by the Start 1013 and Stop 1014 fields. In Fig. 10, the table 1023 shows that between the Start and Stop times, 264K (K=1000's) IP packets and 919 ARP packets were received by the network monitor. The IP packets and ARP packets containing 99M and 55K bytes, respectively (M=1,000,000).

The entries in the table 1023 are selectable to sort data by the selected field. For example, if the packets heading in the table was clicked then the table would be sorted by the packets column in descending order of activity and if this header is clicked again, then it would be sorted in the opposite order. Selection of the other table headings similarly sorts the entries.

Fig. 11 illustrates the zooming capability of the present invention. The start/stop time interval of 7:18/12:02 in Fig. 10 is narrowed to the 9:00/10:00 time interval in Fig. 11. The table 1023 and plots 1032, 1034 have been updated accordingly. The start 1013 and stop 1014 field values may be adjusted by either manual entry in the fields 1013, 1014 themselves, or by graphical selection, by a mouse for example, of an interval of time in the plots 1032, 1034. Upon selection, the display will zoom into the selected interval. Zooming in on the plots causes the plots to be regenerated for the interval selected by the user. Selection of the "Update Tables and Plots" button 1036 will then synchronize data in the tables frame 1010 to the plots 1032, 1034. The plots could also be updated automatically, if the user selected the "auto-synch" feature (not shown). The "Update Tables and Plots" button 1036 allows a user to zoom in several times to a desired time interval without updating the data. This provides the advantage of reducing unnecessary processing by the network monitor until the final interval is chosen.

The protocols listed as entries in the table 1023 in Fig. 10 are selectable by a user, as hyper-links, for example, to list protocols encapsulated within the selected protocol. Clicking or selecting the IP entry in table 1023 in Fig. 10 results in the display of Fig. 12. The selection causes the plots 1032, 1034 in the plots frame 1030 of Fig. 10 to automatically update to show only IP traffic in plots 1232, 1243 in Fig. 12.

The plots illustrate all traffic from the link layer as a line chart 1235 and all IP traffic as a bar chart. This dual-display format provides a graphical representation of the perspective between all traffic of one level (IP in this case) compared to all traffic of a previous level (Ethernet in this case).

The contents of the tables in the tables frame 1210 are also updated to correspond to IP traffic. Table 1223 lists all IP protocols which were in use on the link being monitored between the "Start" and "Stop" times. In this particular case, only TCP, UDP and ICMP IP protocols were found. Activity by IP hosts may also be displayed. By scrolling down the table frame 1210, the table of IP counts by source host is seen as illustrated in Fig. 13 for the case where TopN=2.

In Fig. 13, traffic is displayed in a source host table 1302 for traffic generated by hosts, in a destination host table 1304 for traffic received by a host, and in a host table 1306 for traffic generated and received by a host. Clicking on a link 1308 in the tables frame 1310 will generate a display of a “host-pairs” table 1402 shown in Fig. 14.

5 The host-pairs table 1402 lists the total number of packets and bytes sent between pairs of hosts for each identified pair.

Selection of a “destination host” such as 10.0.0.47 (1404 in Fig. 14) will further filter the traffic by the selected “destination host” to show only traffic destined for host 10.0.0.47. This is illustrated in Fig. 15 where table 1502 shows traffic destined to  
10 10.0.0.47, all from host 128.32.130.10 in this case for traffic monitored between the start and stop interval.

Thus, we see that only host 128.32.130.10 was sending traffic to 10.0.0.47 between the “Start” and “Stop” times. Note that the plots 1532, 1534 in the plots frame 1530 now show this activity between these two hosts as a bar chart 1535 and all IP traffic as a line  
15 chart 1536. Colors may also be used to distinguish the data in the plots or tables.

If the TCP entry in table 1223 in Fig. 12 is selected, we move up the protocol stack and the tables frame 1610 is updated as shown in Fig. 16 to include TCP level counts for each underlying application 1612. For example, there were 27K HTTP (web) packets which contained 21 MegaBytes which were received during the designated time interval.

20 In Fig. 16, if the “TCP flows” button 1604 is selected, all TCP flows are displayed with their time durations and performance metrics as shown in Fig. 17. A TCP flow contains a set of packets belonging to one TCP session between two hosts. Each flow may be plotted or its corresponding packets viewed by selecting the “plot” button 1702 or the “pkts” button 1704, respectively, corresponding to the desired TCP flow. Note that if the  
25 Do DNS option had been selected, all TCP host IP addresses would be replaced by their respective names (e.g. foo.niksun.com). A user may aggregate flows by clicking on other links such as the ones that identify a particular host such as 10.0.0.47. If a user clicks on 10.0.0.47 (1706), aggregated flows for host 10.0.0.47 will be displayed as shown in Fig. 18.

Fig. 18 shows all TCP flows originating from host 10.0.0.47. The display in Fig. 18 is generated by applying a filter selective to the 10.0.0.47 host to the data displayed in Fig. 17. Further filters can similarly be applied by clicking on other hosts (hyperlinks) in Fig. 18. For example, in the "Term host" column, if a user selects host 10.0.0.5 (1802), then all TCP flows between host 10.0.0.47 (as source) and host 10.0.0.5 (as destination) are displayed.

A "TCP performance" selection may be provided, in the screen display of Fig. 16, for example, for generating TCP performance tables. By clicking on the "TCP performance" hyperlink, performance tables 1902 for TCP are displayed as shown in Fig. 19. The whole tables frame is displayed in Fig. 19 or clarity. The display includes a "Troubled TCP Clients" table and a "Troubled TCP Servers" table for the worst two performing TCP clients and servers (TopN field value of 2). Over the time interval specified by the Start and Stop fields, the tables show the following measurements for each TCP client or server:

1. **No. of Connections:** This is the total number of TCP connections to the client or server.
2. **TCP Data Bytes:** This shows the total number of data bytes carried by all the TCP connections.
3. **TCP goodput (Bytes/sec):** This shows the TCP payload throughput (application throughput) or TCP goodput. That is, the total number of application bytes divided by time it takes to send these bytes averaged over the number of connections.
4. **TCP throughput (Bytes/sec):** This shows the total number of bytes carried in the TCP connections divided by time (TCP flow rate).
5. **Avg RTT:** This shows the average Round Trip Time between the client and server over the number of connections.
6. **Avg Response:** This shows the average response time from the server to the client.

7. **Retransmit %:** This shows the percentage of TCP bytes which were retransmitted (due to congestion, loss, or delay, or any other reason).

The TCP performance tables may be customized to add other metrics or delete existing metrics via the user interface.

5       Selecting the http hyperlink in Fig. 16 results in the display of statistics for web traffic (http) as shown in Fig. 20.

An “http performance” selection may be provided, in the screen display of Fig. 20, for example, for generating http performance tables. By clicking on the “http performance” hyperlink, performance tables 2102 for http are displayed as shown in Fig. 10 21. The whole tables frame is displayed in Fig. 21 for clarity. The display includes a “Troubled WWW Clients” table and a “Troubled WWW Servers” table for the worst two performing WWW clients and servers (TopN field value of 2).

The metrics in the http performance tables 2102 may be generated online and displayed to the user as troubled www clients and www servers or may be fed directly to a 15 network management system for immediate action. These metrics can help a network administrator to identify bad servers and connections. This information may also be used to as the basis to notify the web server operator to buy more bandwidth or to fix his server. Further, it can be used to notify clients that they may need more bandwidth or they may need to choose another service provider. Accordingly, these metrics may be used to 20 improve the quality of service given to users and ultimately may provide further revenue to the network administrator. For example, in the table “Troubled WWW Servers”, the second server listed (204.162.96.10) had about 33% web aborts. This could indicate a potential loss of 33% of the customers from this web site.

The tables frame 1610 is updated as shown in Fig. 16 to include TCP level counts 25 for each underlying application 1612. For example, there were 27K HTTP (web) packets which contained 21 MegaBytes which were received during the designated time interval.

Upon selection of the-UDP hyperlink 1240 in Fig. 12, we move up the protocol stack and the display of Fig. 22 is provided to illustrate levels of UDP traffic. In the tables frame 2210, a “UDP Level Counts” tables is displayed showing activity for each UDP

application or UDP port. For example, the display indicated that there were 453 domain packets which contained 69 KiloBytes.

Note that UDP bandwidth usage was only about 0.32% of the total IP (see table 1223 in Fig. 12). Thus, the plots frame shows only IP traffic (RED graph) which dwarfs the UDP traffic (in BLUE). By clicking on the "Toggle Parent Display" the user can now zoom the Y-axis only on the UDP traffic (this is not illustrated) as the plot for IP (parent plot) will be removed.

Selection of the "MBONE" button 2202 in Fig. 22 results in display of an application layer analysis of MBONE (Multimedia backbone) sessions as shown in Fig. 23.

Selection of the "View Packets" button 2204 in the buttons frame 2250 in Fig. 22 gives a dump of all packets as shown in Fig. 24. Since the network monitor can record all packets, all packets and their contents can be viewed. The links in the display of Fig. 24 allow a user to flexibly filter the data streams. If the user clicks on 10.0.0.12 (2402), then the next screen of dumps will only contain packets to and from 10.0.0.12. In that next screen, if a user selected 10.0.0.5, then the updated display would show only packets between 10.0.0.12 and 10.0.0.5. A user could also further qualify the dump by selecting ports. Various options for dumping packets can be applied by selecting a type of dump from the selections 2404 at the top of the screen display.

Selection of the "Recommend" button 2206 in the buttons frame 2250 of Fig. 22 results in the display of real-time capacity or bandwidth recommendations for the network. Upon detection of selection of the "Recommended" button 2206, the network monitor uses a mathematical model to interpret the data being viewed by the user to provide recommendations on bandwidth usage by an application (or other types of traffic) or on setting of link/switch capacity to obtain a specific quality of service. Several such statistics 2502 are shown in Fig. 25. A user may enter desired quality of service values such as loss rates and maximum delays to obtain recommendations on the capacity required to support the desired quality of service for the type of traffic analyzed. Figs. 25 and 26 illustrate the recommendations which can be provided.



In an exemplary embodiment, the user may select a particular application and a "busy-period" for which she wants to "size" the network resources for a particular quality of service level. Appropriate subroutines in the network monitor then analyze the particular application traffic and extract or estimate "model parameters". Using the  
5 mathematical model, and estimates of the parameters, as well as parameters of quality of service (such as packet loss rates, network delays, frame rates, etc.) the model computes statistics such as statistical multiplexing gains, capacity requirements, and buffer allocations and provides the user with optimal recommendations of switch/router configurations, network resources, or server parameters to maximize network utilization  
10 while meeting the quality of service requirements. Such recommendations can be computed on a real-time basis where the statistic is updated for every packet or a set of packets belonging to different services and feedback can be provided to network elements along the path for each flow on optimal configurations to enable dynamic resource allocation to meet service quality requirements.

15 The x-axis 2602 of the graph represents the number of users and the y-axis 2604 represents capacity in bits/second. For a desired number of users, the capacity can be read off the chart or from a display of corresponding tabular results. Fig. 27 illustrates a display similar to that in Fig. 22 for the case where the Do DNS button was selected so the IP addresses are resolved to their registered names.

20 Fig. 28 is a display showing statistics that are displayed upon selection of the "Statistics" button 2208 in the buttons frame 2250 in Fig. 22. Upon selection of the "statistics" button 2208, the network monitor computes various statistics based on data currently being viewed by the user. Exemplary statistics include packet size distributions, protocol distributions, bandwidth usage per client, bandwidth usage by domain, average  
25 response time per server, average round-trip time between server-client pair, and performance metrics.

The present invention is not limited to a particular division of functions between the host computer and the interface computer. The functions of the host computer and the interface computer may be performed by a single computer. Interface with a network

monitor according to the present invention is not limited to the user interface and may be via the network being monitored or another communication line.

Although illustrated and described above with reference to certain specific embodiments, the present invention is nevertheless not intended to be limited to the details shown. Rather, various modifications may be made in the details within the scope and range of equivalents of the claims and without departing from the spirit of the invention.

1 WHAT IS CLAIMED IS:

2 1. A method for collecting and analyzing first data on a first communication line  
3 comprising the steps of:

- 4 (a) receiving the first data from the first communication line;  
5 (b) segregating the received first data into packets;  
6 (c) determining a respective first characteristic of each packet;  
7 (d) selecting packets based on their respective first characteristic;  
8 (e) associating a respective index with each of the selected packets;  
9 (f) converting each of the selected packets into a respective record including its  
10 respective index;  
11 (g) storing the records in a first memory;  
12 (h) determining a respective second characteristic of each packet;  
13 (i) incrementing a first count by an amount corresponding to each respective  
14 second characteristic;  
15 (j) receiving a first count duration; and  
16 (k) storing a separate first count in a second memory corresponding to packets  
17 received during each successive first count duration.

1 2. A method for monitoring data on a first communication line comprising:  
2 receiving the data from the first communication line;  
3 extracting a plurality of packets from the received data; and  
4 recursively generating statistics corresponding to the plurality of packets.

1 3. A method for collecting and analyzing first data transmitted on a first  
2 communication line comprising the steps of:

- 3 (a) receiving the first data from the first communication line;  
4 (b) segregating the received first data into packets;  
5 (c) determining a respective type of each packet;  
6 (d) selecting packets based on their respective type;  
7 (e) associating a respective index with each of the selected packets;

- 8 (f) converting each of the selected packets into a respective record including its  
9 respective index;
- 10 (g) storing the records in a first memory;
- 11 (h) receiving a first duration value corresponding to a first time period;
- 12 (i) generating at least one statistic corresponding to packets received during each  
13 successive time period; and
- 14 (j) storing the at least one statistic for each successive time period in a second  
15 memory.

1 4. The method according to claim 3 further comprising the step of generating  
2 a further statistic using at least one of the stored records and the stored at least one  
3 statistic.

1 5. The method according to claim 3 further comprising the steps of:  
2 receiving a second duration value corresponding to a second time period longer  
3 than the first time period; and  
4 generating a further statistic corresponding to packets received during the second  
5 time period encompassing at least one first time period using at least one of the stored  
6 records and the stored at least one statistic.

1 6. The method according to claim 3 wherein the at least one statistic includes  
2 at least one of a number of bits, a number of bytes, a number of packets, a number of  
3 packets of a predetermined protocol, a number of packets of a predetermined protocol  
4 layer, a number of packets having a predetermined source address, and a number of  
5 packets having a predetermined destination address of a respective packet.

1 7. The method according to claim 3 wherein a record includes a portion of its  
2 respective packet plus its respective index.

1 8. The method according to claim 3 wherein the respective index of a packet  
2 corresponds to a time when the packet was received.

1 9. A method according to claim 8 further comprising the steps of receiving a  
2 time signal from a global positioning satellite indicating an absolute time and generating  
3 the time when a packet was received based on the absolute time.

1           10.    A method according to claim 3 wherein the received packets originated  
2    from a second communication line and each received packet includes an indication of a  
3    respective first time when it was left the second communication line, the method further  
4    comprising:

5           determining a respective second time when each packet is received from the first  
6    communication line; and

7           generating a transmission delay corresponding to each packet by subtracting its  
8    respective second time from its respective first time.

1           11.    A method according to claim 10 wherein the transmission delay  
2    corresponding to each packet is calculated using the equation

3  
4           
$$\text{transmission delay} = (ts1 - ts2) - (\text{link\_speed} / \text{packet\_length})$$

5  
6           where ts1 and ts2 are the first and second times, respectively, the link\_speed is a  
7    data rate on the first transmission line, and the packet\_length is the length of each  
8    respective packet on the first transmission line.

1           12.    The method according to claim 3 wherein step (a) includes receiving the  
2    first data from the first communication line using a non-intrusive coupling to the first  
3    communication line.

1           13.    The method according to claim 3 further comprising the step of receiving  
2    information indicating at least one of a type of packets to be selected in step (d), the first  
3    duration value, and an identification of which statistics to generate in step (i).

1           14.    The method according to claim 13 wherein the information is received via  
2    the first communication line.

1           15.    A method according to claim 3 wherein each packet received from the first  
2    communication line includes a respective source time stamp corresponding to a time of  
3    transmission from a source, the method further comprising:

4           decoding the time of transmission from the respective source of each packet; and

5           generating a transmission delay corresponding to each packet by subtracting its  
6    respective time of transmission from the current time.

1           16.    A method according to claim 15 including the step of receiving the current  
2 time from a global positioning satellite.

1           17.    A method according to claim 3 wherein step (i) includes generating at least  
2 one quality of service value for each successive time period corresponding to packets of a  
3 predetermined packet type received during each respective successive time period.

1           18.    A method according to claim 17 wherein the at least one quality of service  
2 value indicates at least one of a round trip delay, and a retransmit rate corresponding to the  
3 packets of the predetermined packet type received during the respective successive time  
4 period.

1           19.    A method according to claim 3 wherein step (c) includes determining a  
2 respective type of each packet based on at least one of a corresponding application type, a  
3 corresponding packet content, a packet source, and a packet destination.

1           20.    A method according to claim 3 wherein the first communication line is in a  
2 network including a user and step (i) includes generating at least one user profiling statistic  
3 for each successive time period corresponding to packets destined to or from a user which  
4 are received during each respective successive timer period.

1           21.    A method according to claim 3 further comprising the step of using the  
2 records stored in the first memory to generate at least one user profiling statistic for each  
3 successive time period corresponding to packets destined to or from a user which are  
4 received during each respective successive timer period.

1           22.    A method according to claim 3 further comprising the step of receiving an  
2 input from a user identifying a user statistic and step (i) includes generating the user  
3 statistic.

1           23.    A method according to claim 3 further comprising the steps of:  
2 receiving an input from a user identifying a user statistic; and  
3 generating the user statistic using the at least one statistic stored in the second  
4 memory and the records stored in the first memory.

1           24. A method according to claim 3 wherein the first data is transmitted on the first  
2 communication line according to a first protocol, the method further comprising the step of  
3 receiving decoding parameters corresponding to the first protocol and step (a) includes

4 receiving the first data according to the decoding parameters and step (b) includes  
5 segregating the received first data into packets according to the decoding parameters.

1 25. A method according to claim 3 wherein

2 step (i) includes generating a separate count for each of a plurality of packet types  
3 corresponding to a number of packets of each respective one of the plurality of packet types  
4 received during each respective successive time period; and the method further comprises  
5 the step of

6 displaying the plurality of packet types and their corresponding statistics  
7 accumulated over a second time period greater than the first time period in a first portion  
8 of a display area of a display device;

1 26. A method according to claim 25 wherein the plurality of packet types are  
2 selectable by a user and the method further comprises the steps of:

3 receiving a user selection of one of the packet types by a user;  
4 displaying statistics corresponding to packets of the selected packet type received  
5 during the second time period.

1 27. A method according to claim 25 further comprising the step of graphically  
2 displaying the statistics corresponding to the plurality of packet types in a plot over the  
3 second time period in a second portion of the display area.

1 28. A method according to claim 25 further comprising the step of:

2 generating a graphical display of the statistics corresponding to the plurality of  
3 packet types in a plot ranging over the second time period in a second portion of the  
4 display area, wherein the plot includes a plurality of discrete selectable time periods;

5 receiving a user selection of a range of the plurality of discrete selectable time  
6 periods;

7 updating the graphical display to display statistics corresponding to the selected  
8 time periods.

1 29. A method according to claim 3 further comprising the steps of:

2 identifying packets belonging to a data stream;

3 storing stream identification information as one of a separate record and a separate  
4 field in the records corresponding to the identified packets.

1           30. A method according to claim 3 further comprising the step of recreating a data  
2 stream using the stored records and the stored stream identification information.

1           31. A method according to claim 3 wherein  
2 the first communication line is in a network including a second communication  
3 line,

4 step (e) includes determining a respective time value corresponding to a time when  
5 each of the selected packets was received and the respective index associated with each  
6 selected packet includes its respective time value,

7 and step (f) includes converting each of the selected packets into a respective  
8 record which includes a uniquely identifiable portion of the respective selected packet;

9 and the method further comprises the steps of:

10 receiving second data from the second communication line;

11 segregating the second data into packets;

12 determining a respective type of each packet received from the second  
13 communication line;

14 selecting packets received from the second communication line based on their  
15 respective type;

16 determining a respective time when each of the selected packets received from the  
17 second communication line was received;

18 associating a respective index with each of the selected packets received from the  
19 second communication line, the respective index corresponding to a time when the packet  
20 was received from the second communication line;

21 convert each of selected packets received from the second communication line into  
22 a respective record that includes a uniquely identifiable portion the selected packet from  
23 the second communication line and includes its respective index;

24 storing the records corresponding to the selected packets received from the second  
25 communication line in a third memory;

26 comparing the uniquely identifiable portions of packets in records stored in the  
27 second memory to those in records stored in the third memory to determine which selected



28 packets received from the first communication line correspond to packets received from  
29 the second communication line to generate matched pairs of packets;

30 generating a transmission delay corresponding to each matched pair of packets  
31 using their respective indexes.

1 32. The method according to claim 31 wherein the transmission delay for a  
2 particular packet is calculated using the equation

3  
4 
$$\text{transmission delay} = (ts1-ts2) - (\text{link\_speed} / \text{packet\_length})$$

5  
6 where ts1 and ts2 are the times of receipt of the matched packets from the first and  
7 second transmission lines, respectively, the link\_speed is a data rate on the first  
8 transmission line, and the packet\_length is the length of the matched packet on the first  
9 transmission line, when ts1 is later than ts2, and

10 where ts1 and ts2 are the times of receipt of the matched packets from the second  
11 and first transmission lines, respectively, the link\_speed is a data rate on the second  
12 transmission line, and the packet\_length is the length of the matched packet on the second  
13 transmission line, when ts2 is later than ts1.

1 33. A method according to claim 32 wherein the first communication line  
2 transmits data using a first protocol and the second communication line transmits data  
3 using a second protocol different from the first protocol.

1 34. A method according to claim 31 wherein the transmission delay is  
2 generated at a level of accuracy less than 10 microseconds.

1 35. A method for routing data from a first point to a second point in a  
2 communication network including a plurality of paths between the first point and the  
3 second point, the method comprising the steps of:

4 generating flow statistics based on the flow of other data on the plurality of paths  
5 between the first point and the second point;

6 routing the data between the first and second points based on the generated flow  
7 statistics.

1           36.     A method of displaying packet properties on a display device having a  
2 display area, the packet properties corresponding to packets received from a first  
3 communication line during an interval of time, the method comprising:

4           (a)     displaying a table listing the packet properties in a first portion of the  
5 display area; and

6           (b)     displaying a plot of the packet properties over the time interval in a second  
7 portion of the display area, the plot having two axes, the packet properties being  
8 represented on one axis of the plot, and time represented on the other axis of the plot.

1           37.     The method according to claim 36 wherein the packets correspond to a  
2 plurality of protocols at a protocol layer wherein step (a) includes displaying a table listing  
3 each of the plurality of protocols and a corresponding number of packets.

1           38.     The method according to claim 37, further comprising the steps of detecting  
2 selection of one of the plurality of protocols and updating the table to display packet  
3 properties corresponding to packets of the selected protocol and to display a dual plot  
4 including the packet properties of the selected protocol and the packet properties of all  
5 protocols.

1           39.     The method according to claim 36 further comprising the step of receiving  
2 a selection of a sub-interval of time less than the interval of time by one of entry of times  
3 in a text field or selection of a time interval along the time axis of the plot.

1           40.     The method according to claim 39 further comprising updating at least one  
2 of the tables and the plots to correspond to the selected sub-interval of time.

1           41.     The method according to claim 36 further comprising the steps of receiving  
2 a start time and an end time spanning a duration longer than the time interval and updating  
3 at least one of the tables and the plots to correspond to the duration.

1           42.     The method according to claim 36 wherein a subset of the packets  
2 correspond to a host and the method further comprises detecting selection of the host and  
3 displaying statistics corresponding to the subset of packets.

1           43.    The method according to claim 36 wherein the packets correspond to a  
2    plurality of protocols and a subset of the packets correspond to one of the plurality of the  
3    protocols and the method further comprises detecting selection of the one of the plurality  
4    of the protocols and displaying statistics corresponding to the selected one of the plurality  
5    of protocols.

1           44.    A method of synchronizing host clock on a host computer with an interface  
2    clock on a network interface card comprising the steps of:

3            requesting an interface clock value from the network interface card;

4            reading an interface clock value;

5            generating an adjusted interface clock value by subtracting a predetermined service  
6    time from the interface clock value ;

7            providing the adjusted interface clock value to the host computer;

8            reading a host clock value;

9            correlating the adjusted interface clock value with the host clock value.

1           45.    A method of monitoring communications on a network having a first  
2    communication line and a second communication line different from the first  
3    communication line, the method comprising the steps of:

4           (a)    receiving a first plurality of packets from the first communication line with  
5    a first network monitor;

6           (b)    receiving a second plurality of packets from the second communication line  
7    with a second network monitor; and

8           (c)    correlating the first plurality and the second plurality of packets.

1           46.    The method according to claim 45 wherein step (c) includes extracting a  
2    uniquely identifying portion of each of the first plurality and second plurality of packets  
3    and comparing the uniquely identifying portions of the first plurality of packets to those of  
4    the second plurality of packets to generate matched pairs of packets.

1           47.    The method according to claim 45 wherein step (a) includes time stamping  
2   the first plurality of packets, step (b) includes time stamping the second plurality of  
3   packets, and the method further comprises the step of synchronizing the first and second  
4   network monitors with an absolute clock reference.

1           48.    The method according to claim 47 wherein the network monitors are  
2   synchronized by receiving a time signal from a global positioning satellite.

1           49.    A system for monitoring communication on a network including a first  
2   communication line and a second communication line, the system comprising:

3           a first network monitor having a first clock and coupled to the first communication  
4   line for receiving first data from the first communication line;

5           a second network monitor having a second clock and coupled to the second  
6   communication line for receiving second data from the second communication line;

7           synchronizing means for synchronizing the first clock with the second clock.

1           50.    A system according to claim 49 wherein the first clock and the second  
2   clock are synchronized within one microsecond of each other.

1           51.    A system according to claim 49 wherein the synchronizing means  
2   comprises:

3           a receiver associated with the first network monitor for receiving a time signal  
4   from a common clock reference; and

5           a receiver associated with the second network monitor for receiving a time signal  
6   from the common clock reference.

1           52.    A system according to claim 51 wherein the common clock reference is a  
2   global positioning satellite system.

1           53.    A method for billing a user of a communication network comprising steps  
2   of:

3           determining a quality of service metric corresponding to the user's use of the  
4   communication network;

5 billing the user based on the determined quality of service.

1 54. A method of transmitting data onto a communication line comprising the  
2 steps of:

3 associating a time with the data;

4 generating a packet including a plurality of fields, wherein at least one field  
5 corresponds to the associated time and at least one field corresponds to the data;

6 transmitting the packet onto the communication line.

1 55. An apparatus for transmitting data onto a communication line comprising:

2 a clock for providing a time value;

3 an encoder for encoding a packet including a plurality of fields, wherein at least  
4 one field corresponds to the time value and at least one field corresponds to the data;

5 a transmitter for providing the packet to a communication line.

1 56. A system for monitoring a computer network over an interval of time, in  
2 which data packets travel across network paths during such time interval, the system  
3 comprising:

4 means for recording the packets substantially continuously during the time interval;

5 means for extracting packet properties from the recorded packets at multiple,  
6 successive sampling times during said time interval, the time from the beginning of the  
7 time interval to successive sampling times defining subintervals of time during which the  
8 network has been monitored, the subintervals being increasingly longer as packet  
9 properties are extracted over successive sampling times during the time interval;

10 means for tabulating the extracted packet properties for the subintervals to create  
11 statistical information;

12 means for altering the recording of the packets and the extraction of packet  
13 properties in response to user selections;

14 means for creating, during the time interval, data corresponding to graphical  
15 representations of the statistical information in response to the creation of the statistical  
16 information;

17 means for displaying said graphical representations in response to the creation of  
18 said graphical representations.

1 57. The system of claim 56, wherein the recording means includes:  
2 means for detecting the packets travelling over a selected one of the network  
3 paths;  
4 means for indexing the detected packets;  
5 means for creating records corresponding to the packets; and  
6 means for storing the records in memory.

1 58. The system of claim 57, wherein the detecting means includes means for  
2 determining packet properties and means for selecting certain ones of the data packets  
3 traveling the network path and having a predetermined packet property.

1 59. The system of claim 57, wherein the indexing means comprises means for  
2 timestamping the data packets.

1 60. The system of claim 59, in which the network is monitored at two points on  
2 the network, the system further comprising timestamping means at the two points, and  
3 wherein the timestamping means comprises GPS means for synchronizing the indexing of  
4 the data packets at the two points.

1 61. The system of claim 57 further comprising a computer with a data storage  
2 device, a network card having network card memory, and a CPU in logical communication  
3 with the network card, and wherein the record storing means comprises:

4 means for storing the records on the network card memory;  
5 means for detecting relative inactivity of the CPU; and  
6 means for transferring records stored on the network card memory to the data  
7 storage device in response to detection of the relative inactivity of the CPU.

1 62. The system of claim 61, wherein the record storing means further  
2 comprises:

3 a long-term storage device having replaceable storage media loaded therein so as to  
4 receive data thereon, and a magazine of additional storage media operatively connected to  
5 the long-term storage device;

6 means for detecting when the data storage device of the computer contains a  
7 predetermined amount of data corresponding to the recorded packets, said predetermined  
8 amount of data corresponding to the data storage device being full;

9 means for transferring said data from the data storage device to the long-term  
10 storage device in response to detecting the data storage device is full;

11 means for detecting when the replaceable media loaded in the long-term storage  
12 device is full; and

13 means for replacing the full storage media with storage media from the magazine.

1 63. The system of claim 56, wherein the displaying means includes a computer  
2 display screen having a graphical user interface and a control program for the graphical  
3 user interface, the control program having:

4 means for displaying at least some of the packet properties over time on a graph  
5 having two axes, the packet properties being represented on one axis of the graph, the time  
6 being represented on the other axis of the graph;

7 means for varying the timescale of the graph in response to user selection; and

8 means for displaying at least some of the statistical information in at least one table  
9 adjacent to the graph, the tables having user-selectable cells therein; and

10 means, responsive to selection of one of the cells, for displaying additional  
11 statistical information corresponding to the selected cell.

1 64. A system for monitoring data on a first communication line comprising:

2 a packetizer for receiving the data from the first communication line and extracting  
3 a plurality of packets from the data;

4 means for recursively generating statistics corresponding to the plurality of  
5 packets.

1 65. A system according to claim 64 wherein the means for recursively  
2 generating statistics comprises:

3 means for generating records corresponding to the plurality of packets;

4 a filter for identifying packets from the plurality of packets received by the system  
5 during a time period;

6 means for generating first statistics corresponding to the plurality of packets  
7 received by the system during the time period;

8 a memory for storing at least one of the plurality of packets, the records  
9 corresponding to the plurality of packets, and the first statistics;

10 a packet type identifier for identifying a type of packets received from one of the  
11 packetizer, the record generator, and the memory;

12 means for generating second statistics using at least one of the first statistics and  
13 the received packets.

1 66. A system according to claim 64 further comprising a display device for  
2 displaying the generated statistics.

1 67. A system according to claim 65 further comprising a user interface for  
2 defining at least one of the first statistics, the second statistics, and the time period.

1 68. A system according to claim 65 further comprising:

2 a time source synchronized to an absolute time source; and

3 means for determining a time when each respective one of the plurality of packets  
4 was received from the first communication line.

1 69. A system according to claim 68 wherein the time source is a receiver for  
2 receiving a time signal from a global positioning satellite.

1 70. An article of manufacture comprising a computer useable medium having  
2 computer readable program code means embodied therein for monitoring data on a first  
3 communication line, the computer readable program code means in said article of  
4 manufacture comprising computer readable program code means for causing a computer to  
5 effect:

6 receiving the data from the first communication line;

7 extracting a plurality of packets from the received data; and

8 recursively generating statistics corresponding to the plurality of packets.

1 71. A computer program product comprising a computer useable medium  
2 having computer readable program code means embodied therein for monitoring data on a  
3 first communication line, said computer readable program code means in said computer



4 program product comprising computer readable program code means for causing a  
5 computer to effect:receiving the data from the first communication line;

6 extracting a plurality of packets from the received data; and

7 recursively generating statistics corresponding to the plurality of packets.

1 72. A program storage device readable by machine, tangibly embodying a  
2 program of instructions executable by the machine to perform method steps for monitoring  
3 data on a first communication line, said method steps comprising:

4 receiving the data from the first communication line;

5 extracting a plurality of packets from the received data; and

6 recursively generating statistics corresponding to the plurality of packets.

1 73. An article of manufacture comprising a computer useable medium having  
2 computer readable program code means embodied therein for displaying packet properties  
3 on a display device having a display area, the packet properties corresponding to packets  
4 received from a first communication line during an interval of time, the computer readable  
5 program code means in said article of manufacture comprising computer readable program  
6 code means for causing a computer to effect:

7 (a) displaying a table listing the packet properties in a first portion of the  
8 display area; and

9 (b) displaying a plot of the packet properties over the time interval in a second  
10 portion of the display area, the plot having two axes, the packet properties being  
11 represented on one axis of the plot, and time represented on the other axis of the plot.

1 74. A computer program product comprising a computer useable medium  
2 having computer readable program code means embodied therein for causing displaying  
3 packet properties on a display device having a display area, the packet properties  
4 corresponding to packets received from a first communication line during an interval of  
5 time, said computer readable program code means in said computer program product  
6 comprising computer readable program code means for causing a computer to effect:(a)

7 displaying a table listing the packet properties in a first portion of the display area;  
8 and

9           (b) displaying a plot of the packet properties over the time interval in a second  
10 portion of the display area, the plot having two axes, the packet properties being  
11 represented on one axis of the plot, and time represented on the other axis of the plot.

1           75. A program storage device readable by machine, tangibly embodying a  
2 program of instructions executable by the machine to perform method steps for displaying  
3 packet properties on a display device having a display area, the packet properties  
4 corresponding to packets received from a first communication line during an interval of  
5 time, said method steps comprising:

6           (a) displaying a table listing the packet properties in a first portion of the  
7 display area; and

8           (b) displaying a plot of the packet properties over the time interval in a second  
9 portion of the display area, the plot having two axes, the packet properties being  
10 represented on one axis of the plot, and time represented on the other axis of the plot.

1           76. An article of manufacture comprising a computer useable medium having  
2 computer readable program code means embodied therein for collecting and analyzing  
3 first data transmitted on a first communication line, the computer readable program code  
4 means in said article of manufacture comprising computer readable program code means  
5 for causing a computer to effect:

6           (a) receiving the first data from the first communication line;

7           (b) segregating the received first data into packets;

8           (c) determining a respective type of each packet;

9           (d) selecting packets based on their respective type;

10           (e) associating a respective index with each of the selected packets;

11           (f) converting each of the selected packets into a respective record including its  
12 respective index;

13           (g) storing the records in a first memory;

14           (h) receiving a first duration value corresponding to a first time period;

15           (i) generating at least one statistic corresponding to packets received during each  
16 successive time period; and

17 (j) storing the at least one statistic for each successive time period in a second  
18 memory.

1 77. A computer program product comprising a computer useable medium  
2 having computer readable program code means embodied therein for collecting and  
3 analyzing first data transmitted on a first communication line, said computer readable  
4 program code means in said computer program product comprising computer readable  
5 program code means for causing a computer to effect:

- 6 (a) receiving the first data from the first communication line;
- 7 (b) segregating the received first data into packets;
- 8 (c) determining a respective type of each packet;
- 9 (d) selecting packets based on their respective type;
- 10 (e) associating a respective index with each of the selected packets;
- 11 (f) converting each of the selected packets into a respective record including its  
12 respective index;
- 13 (g) storing the records in a first memory;
- 14 (h) receiving a first duration value corresponding to a first time period;
- 15 (i) generating at least one statistic corresponding to packets received during each  
16 successive time period; and

17 (j) storing the at least one statistic for each successive time period in a second  
18 memory.

1 78. A program storage device readable by machine, tangibly embodying a  
2 program of instructions executable by the machine to perform method steps for collecting  
3 and analyzing first data transmitted on a first communication line, said method steps  
4 comprising:

- 5 (a) receiving the first data from the first communication line;
- 6 (b) segregating the received first data into packets;
- 7 (c) determining a respective type of each packet;
- 8 (d) selecting packets based on their respective type;
- 9 (e) associating a respective index with each of the selected packets;

- 10           (f) converting each of the selected packets into a respective record including its  
11 respective index;
- 12           (g) storing the records in a first memory;
- 13           (h) receiving a first duration value corresponding to a first time period;
- 14           (i) generating at least one statistic corresponding to packets received during each  
15 successive time period; and
- 16           (j) storing the at least one statistic for each successive time period in a second  
17 memory.

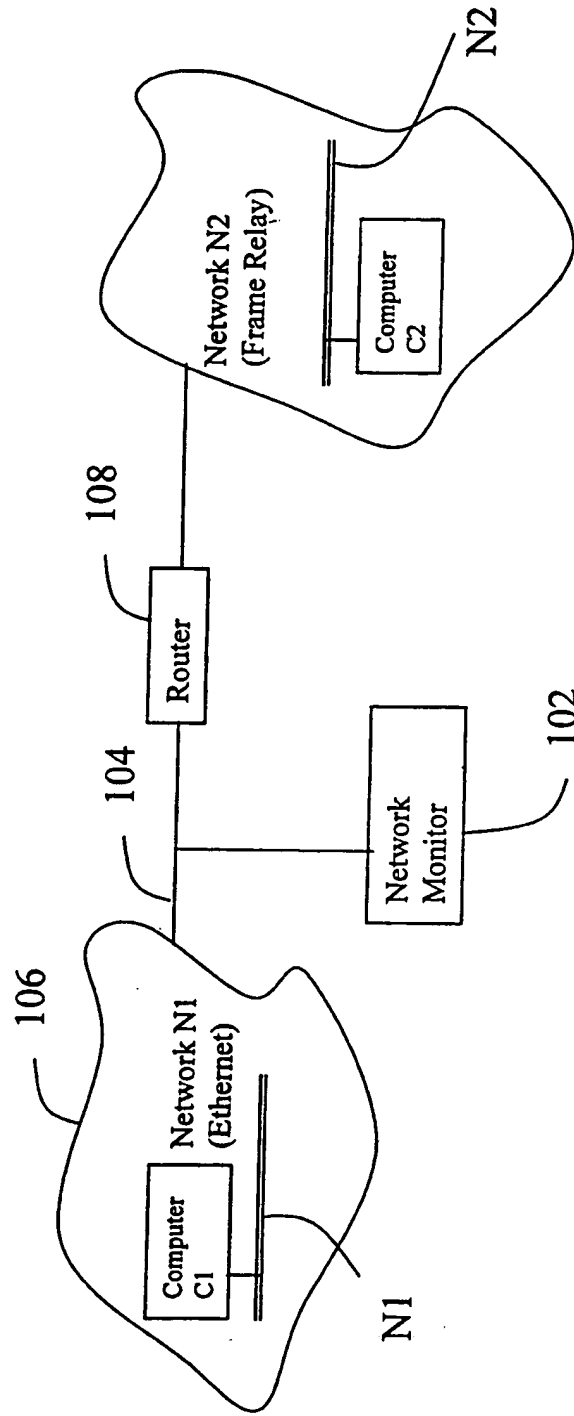

FIG. 1

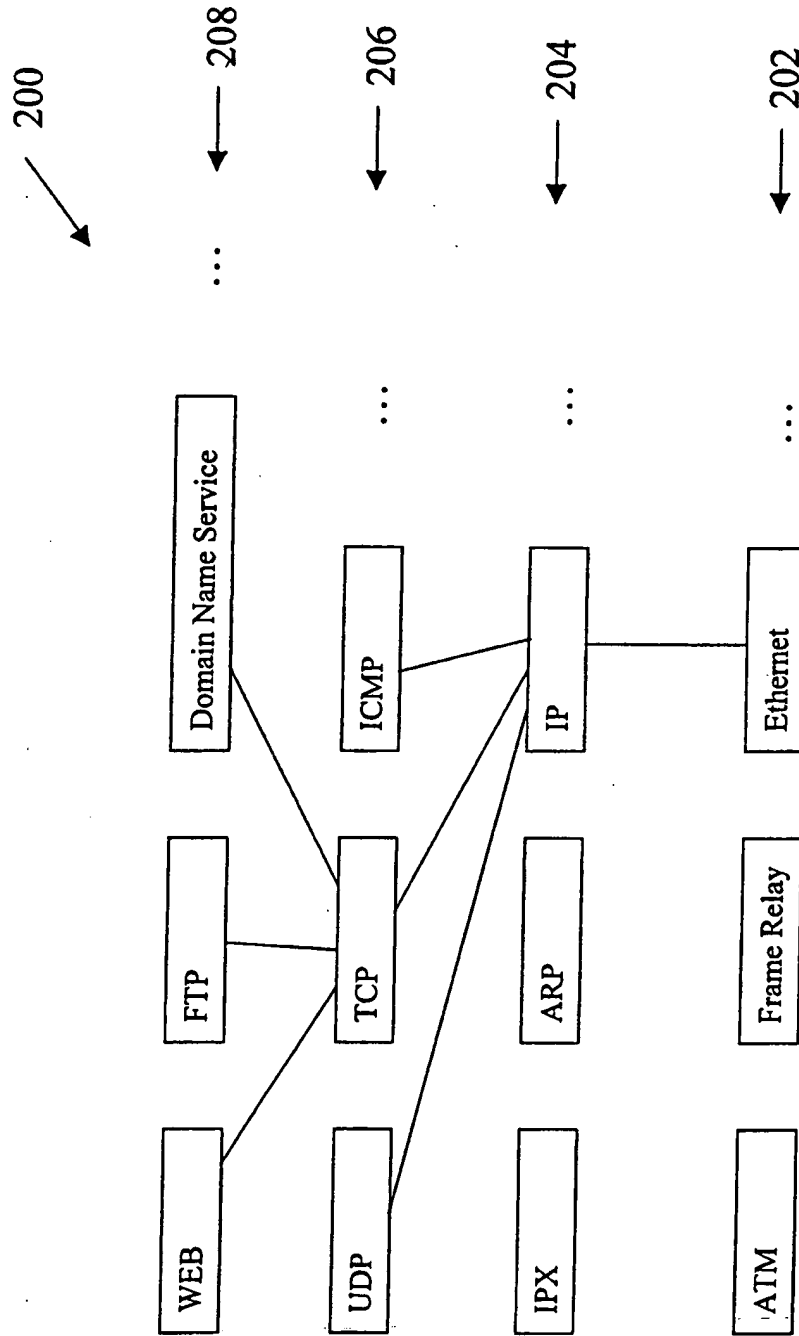

FIG. 2

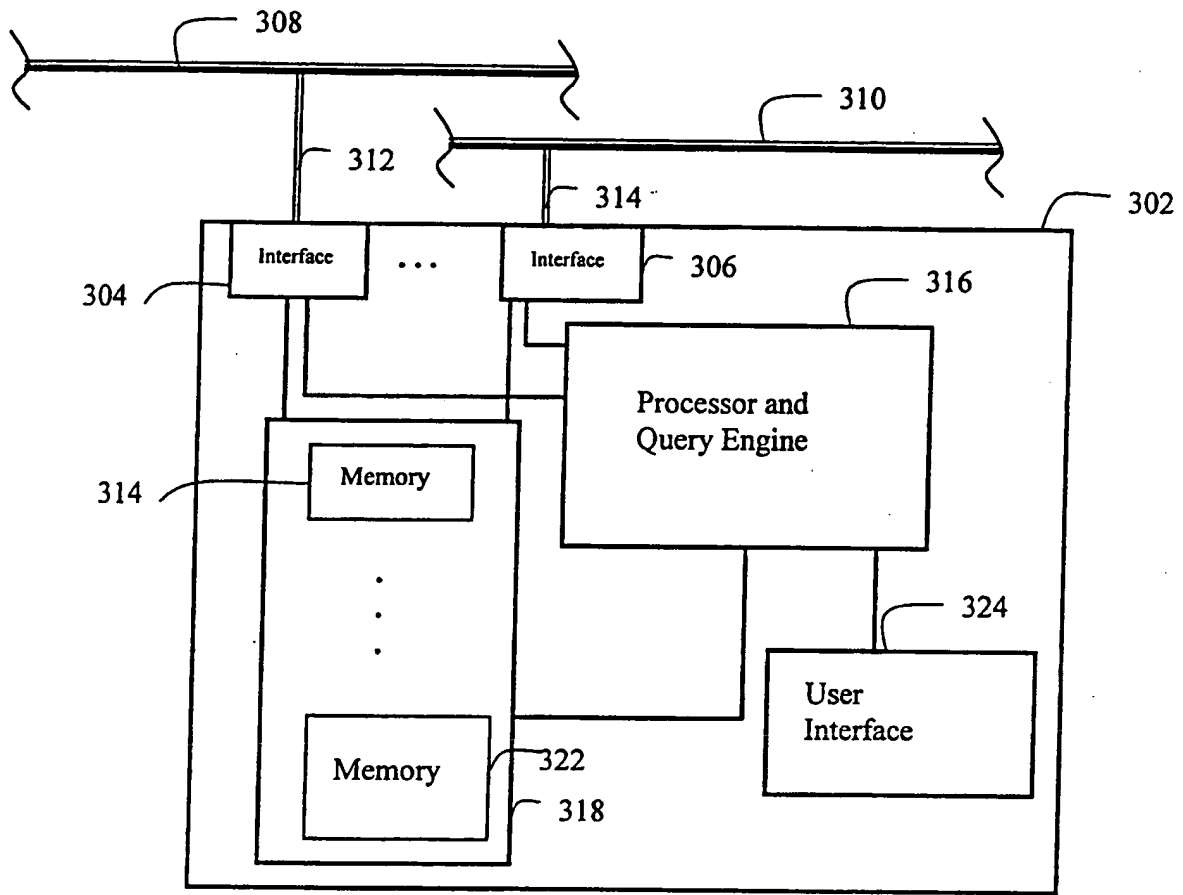
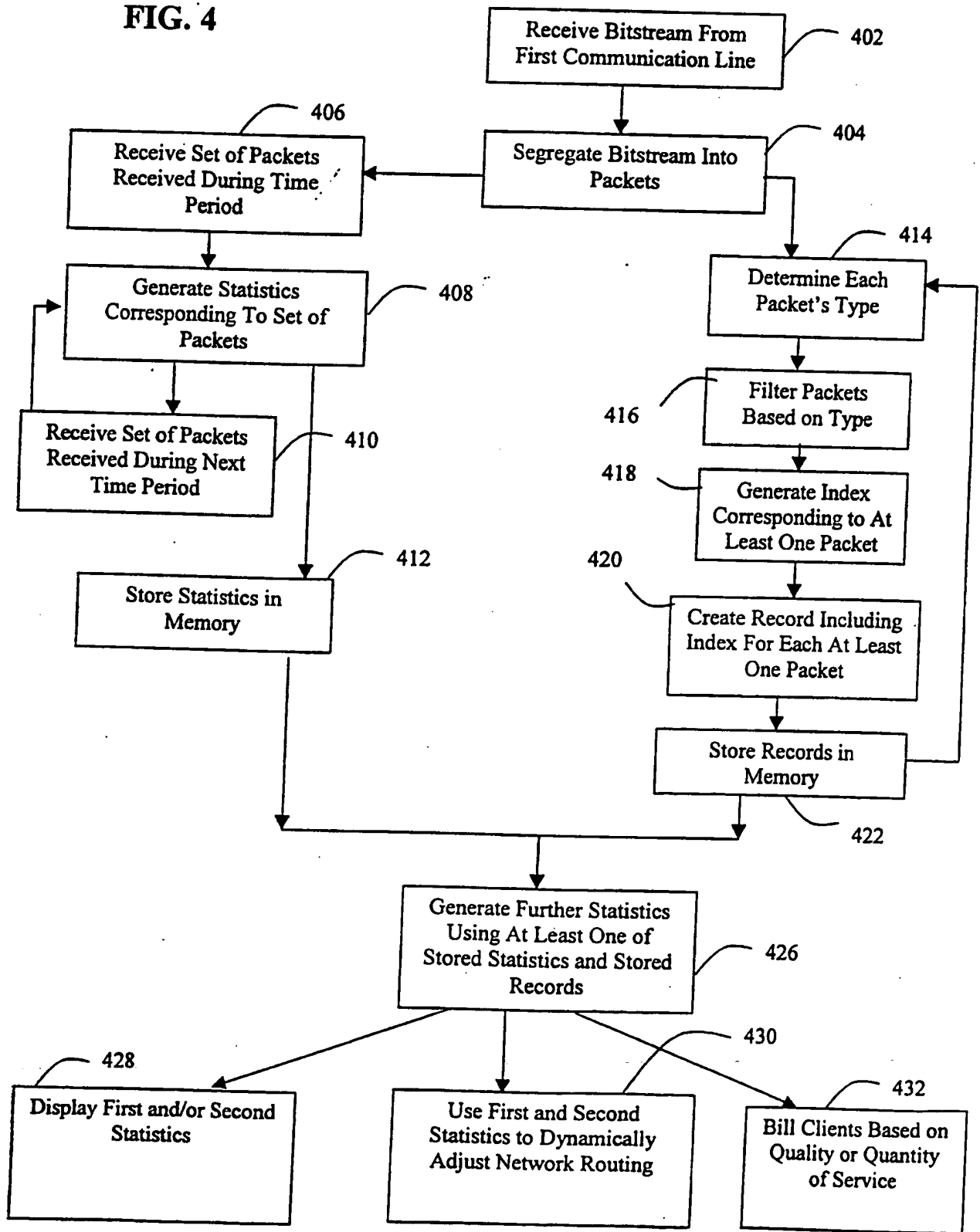

FIG. 3

FIG. 4





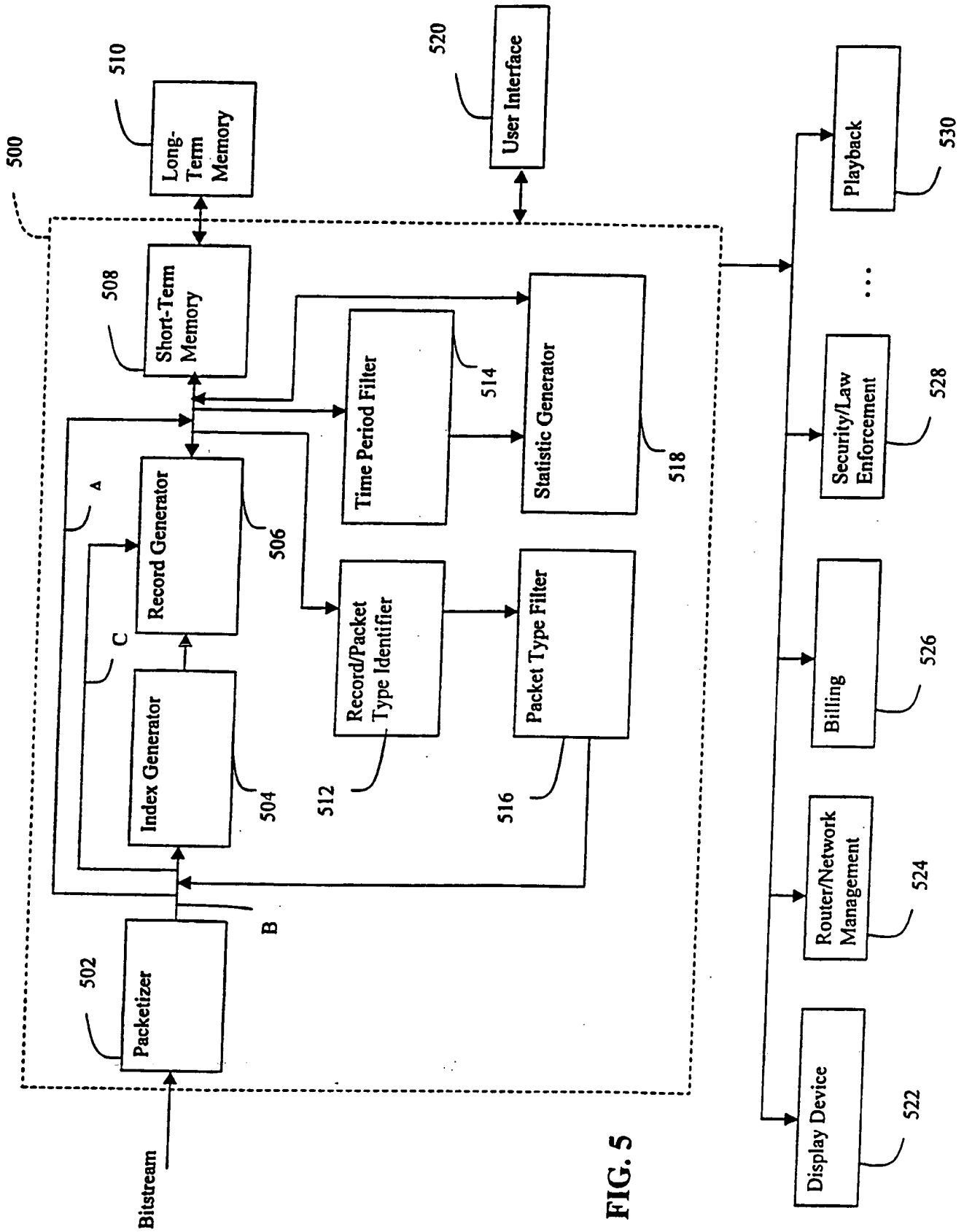

FIG. 5

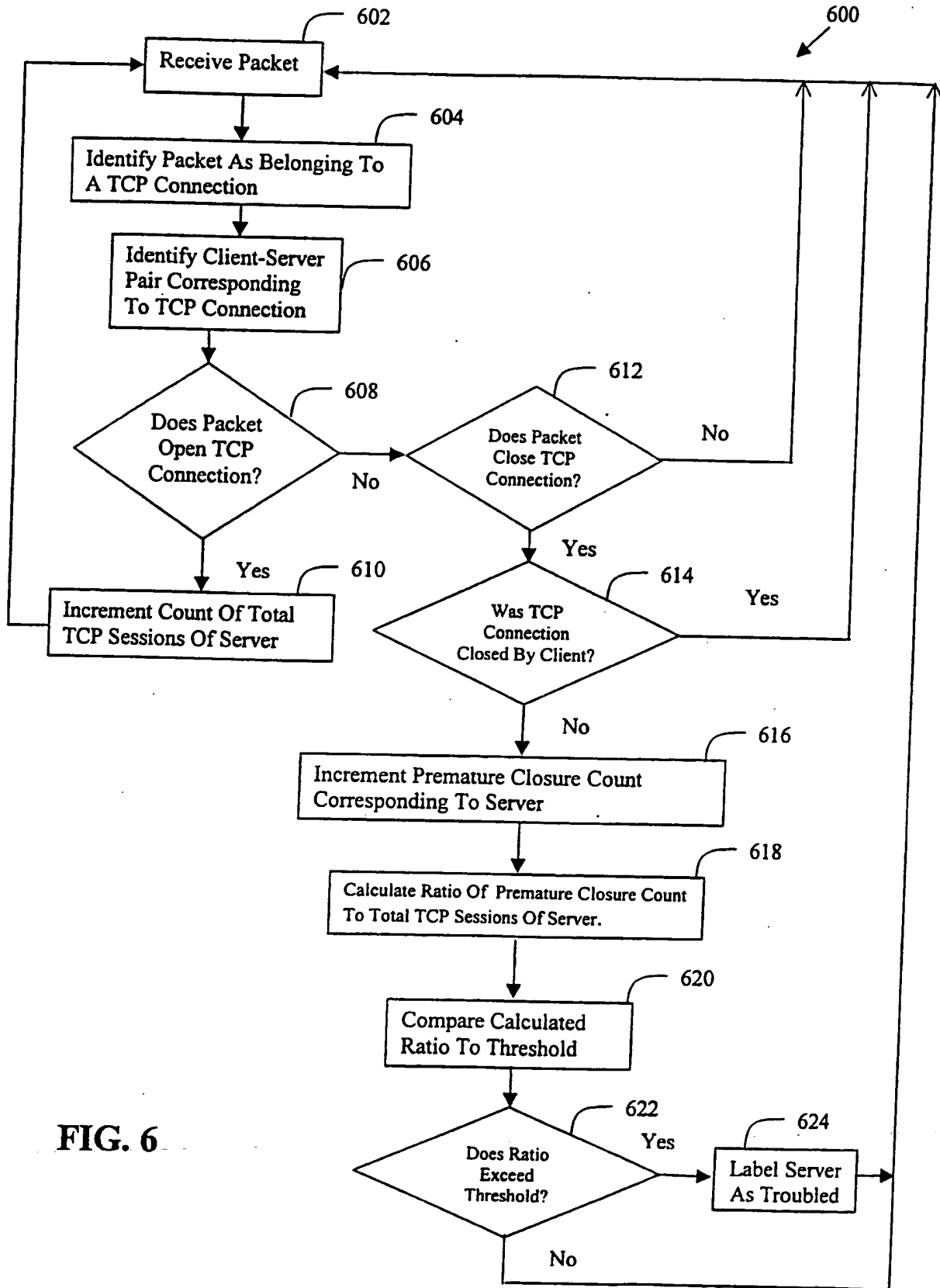

FIG. 6

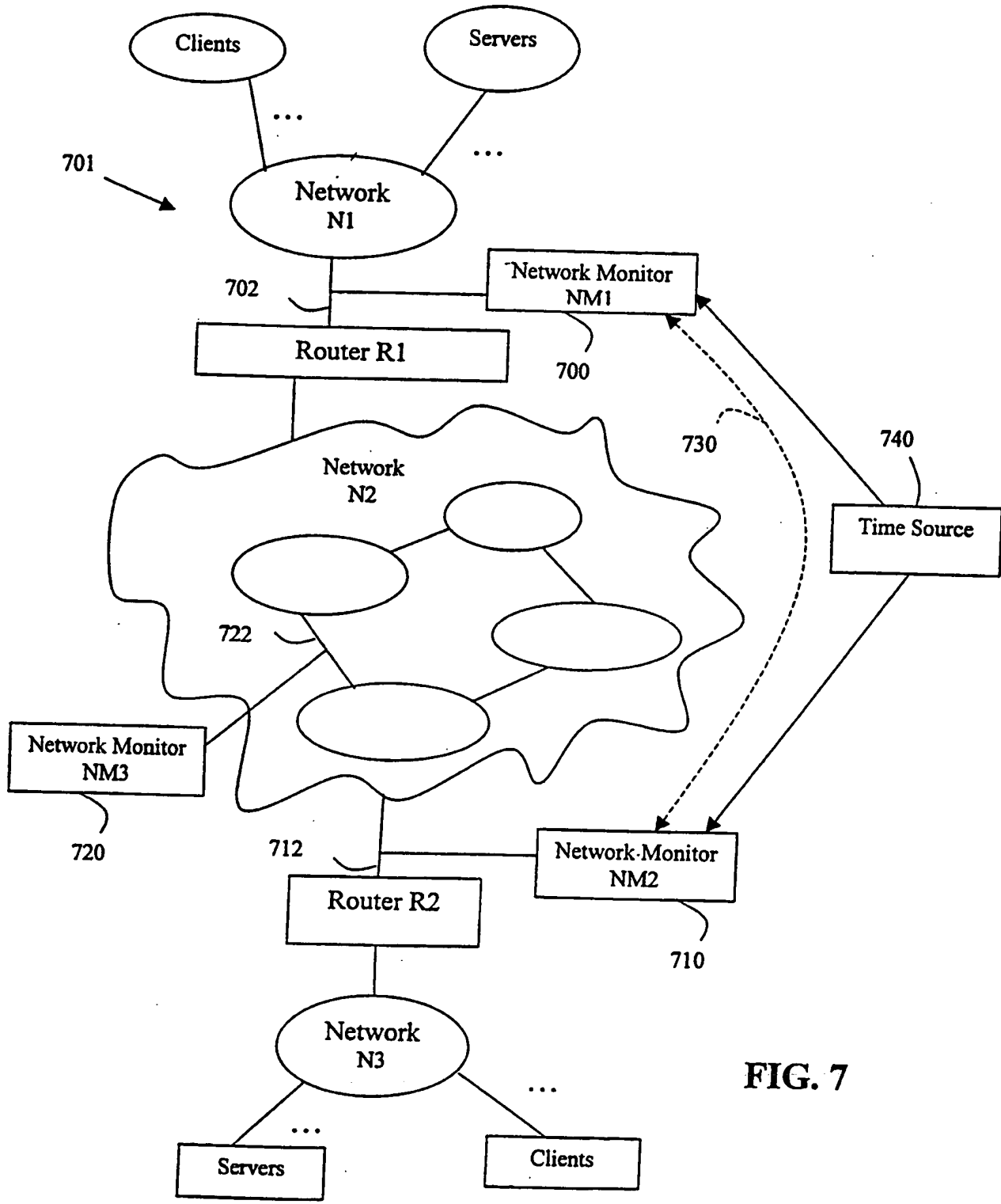

FIG. 7

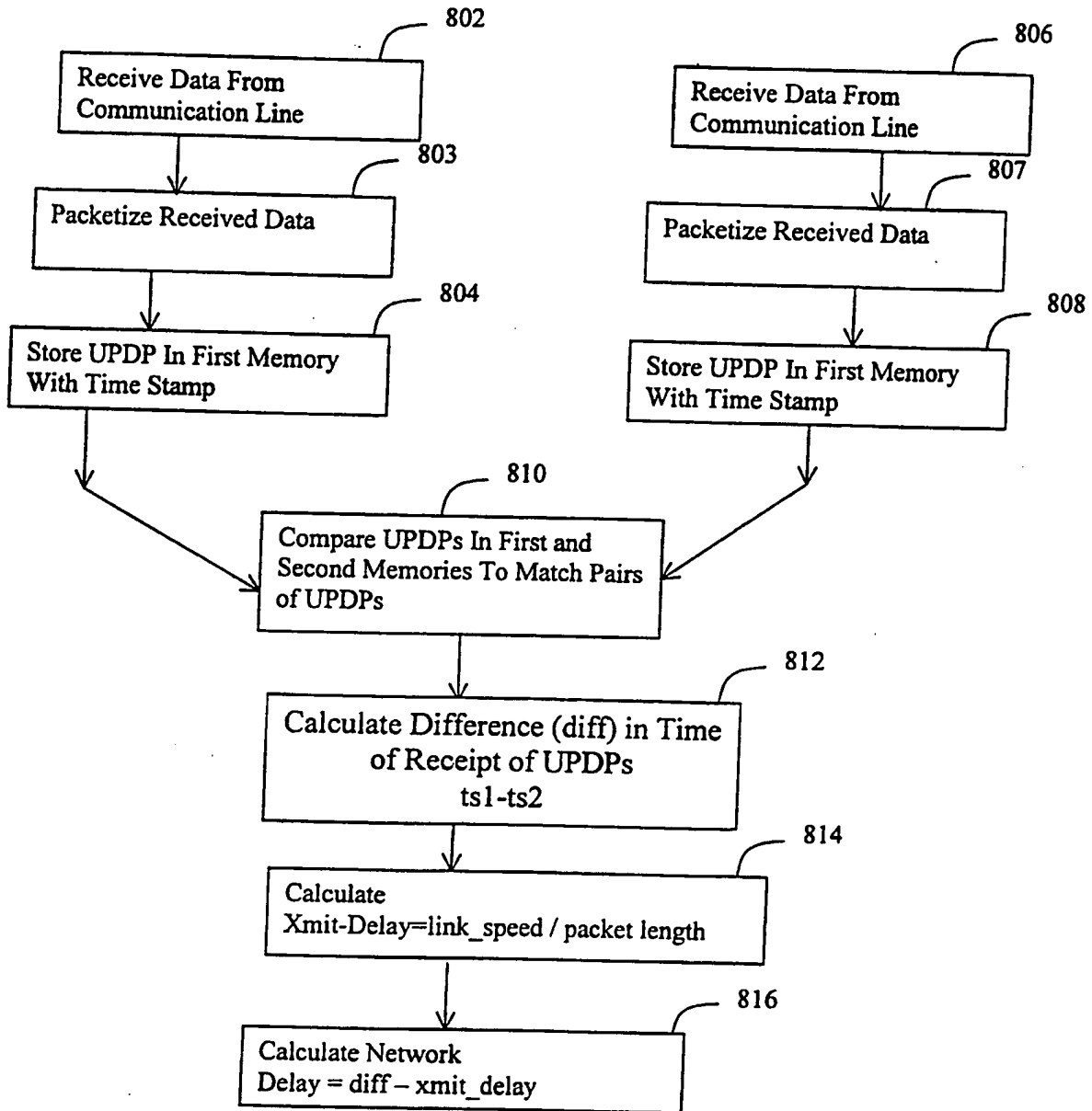

FIG. 8

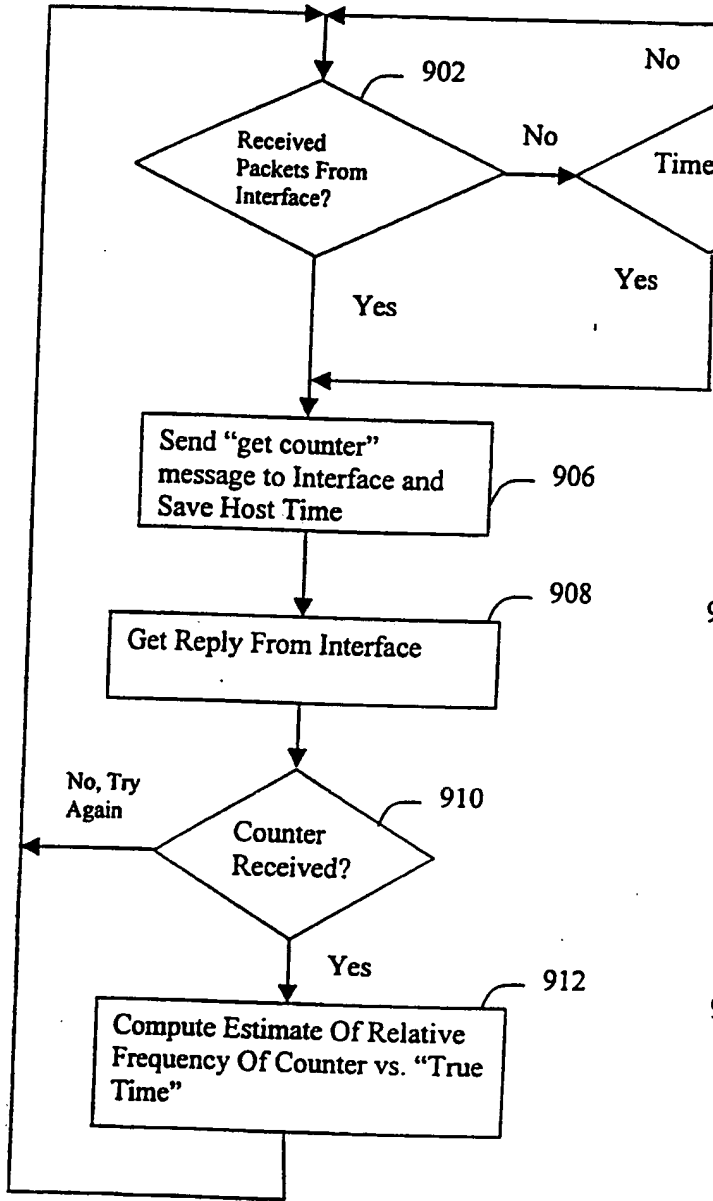

FIG. 9A

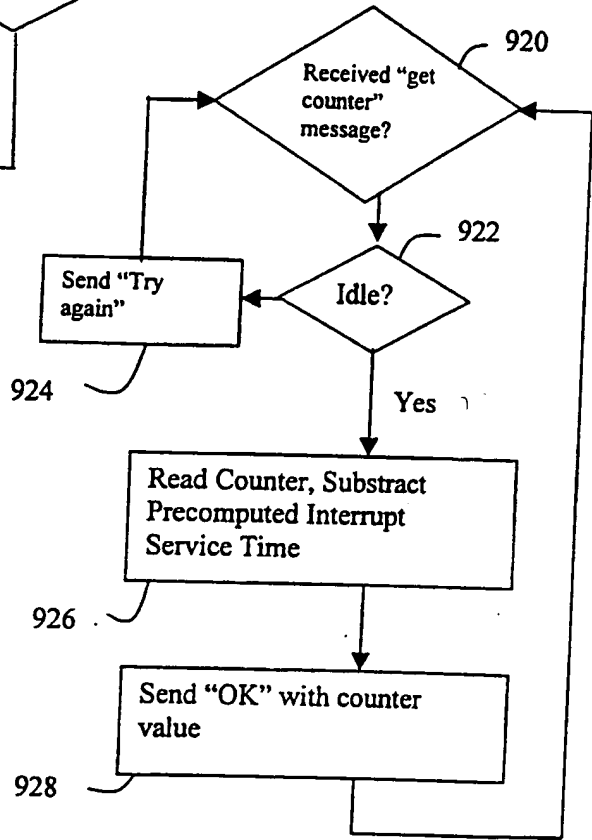

FIG. 9B

FIGURE 10

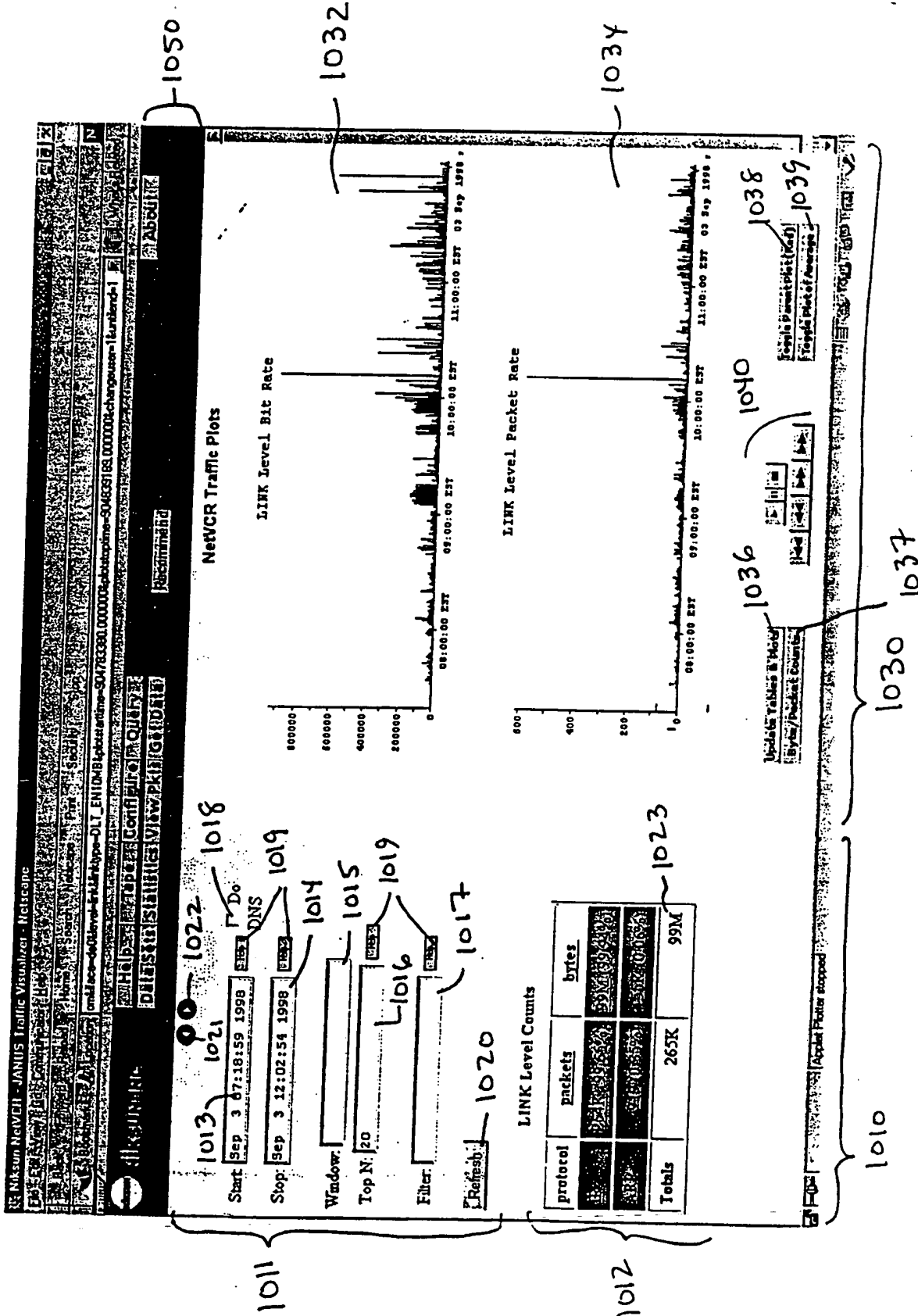

FIGURE 11

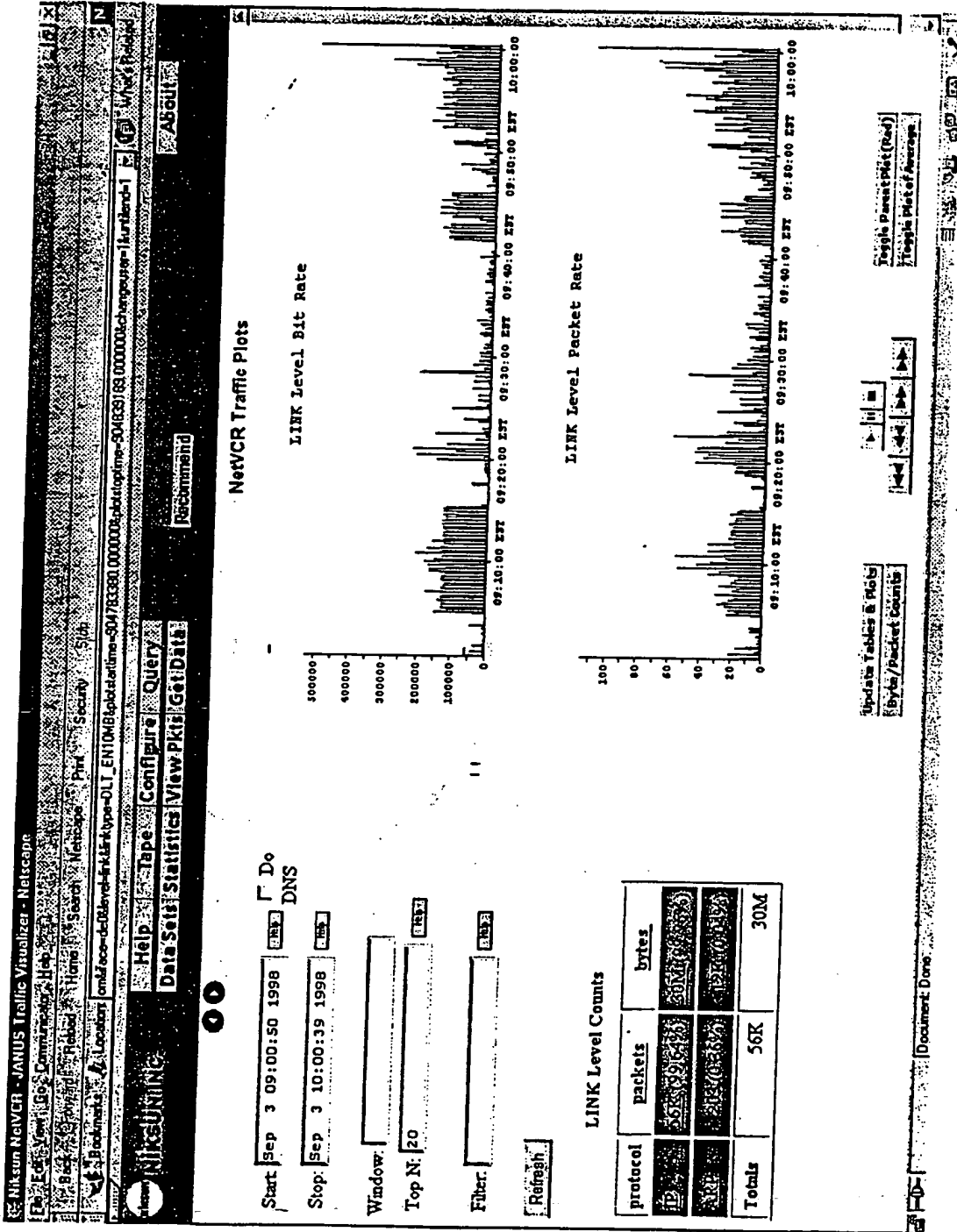

FIGURE 12

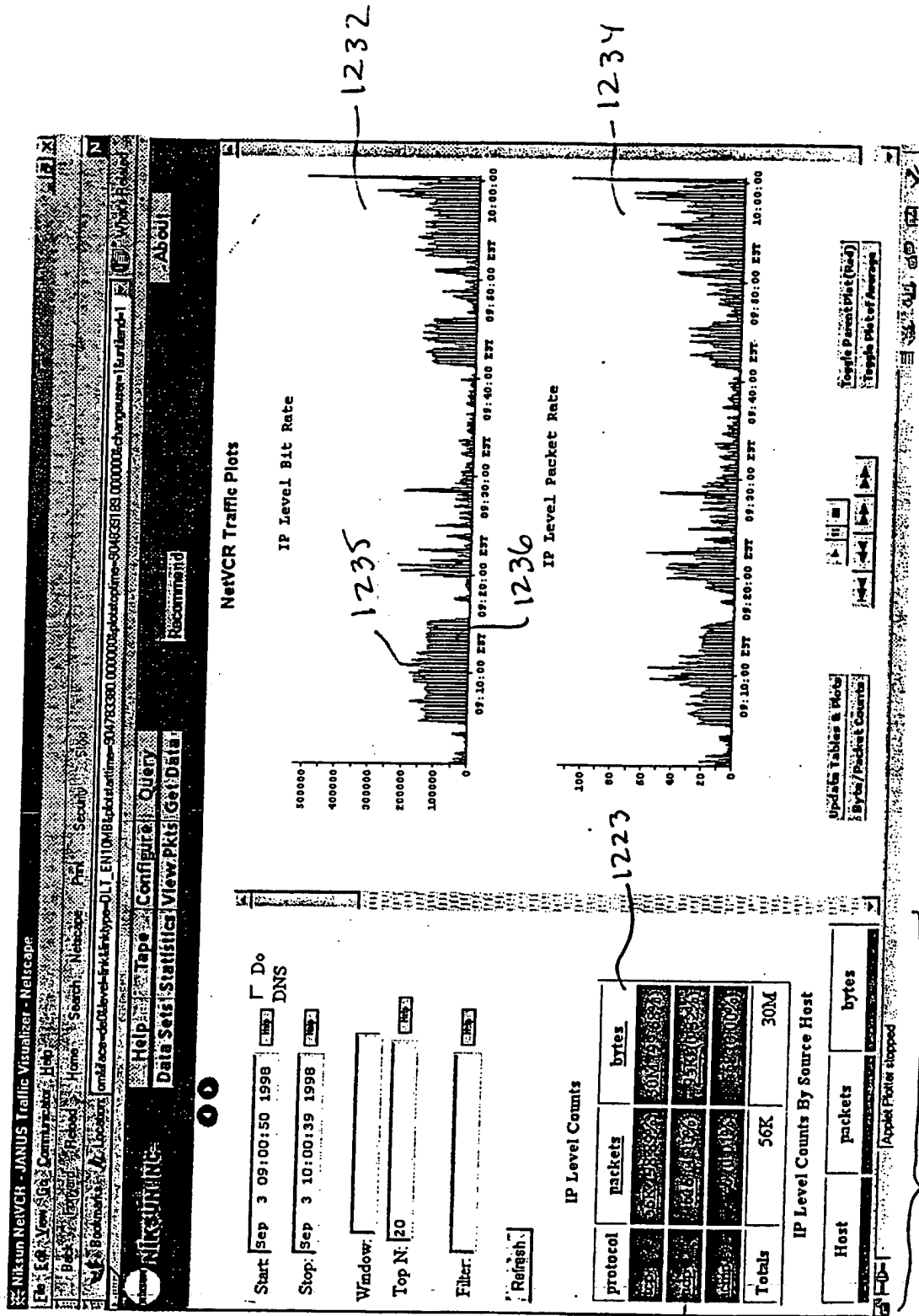



FIGURE 13

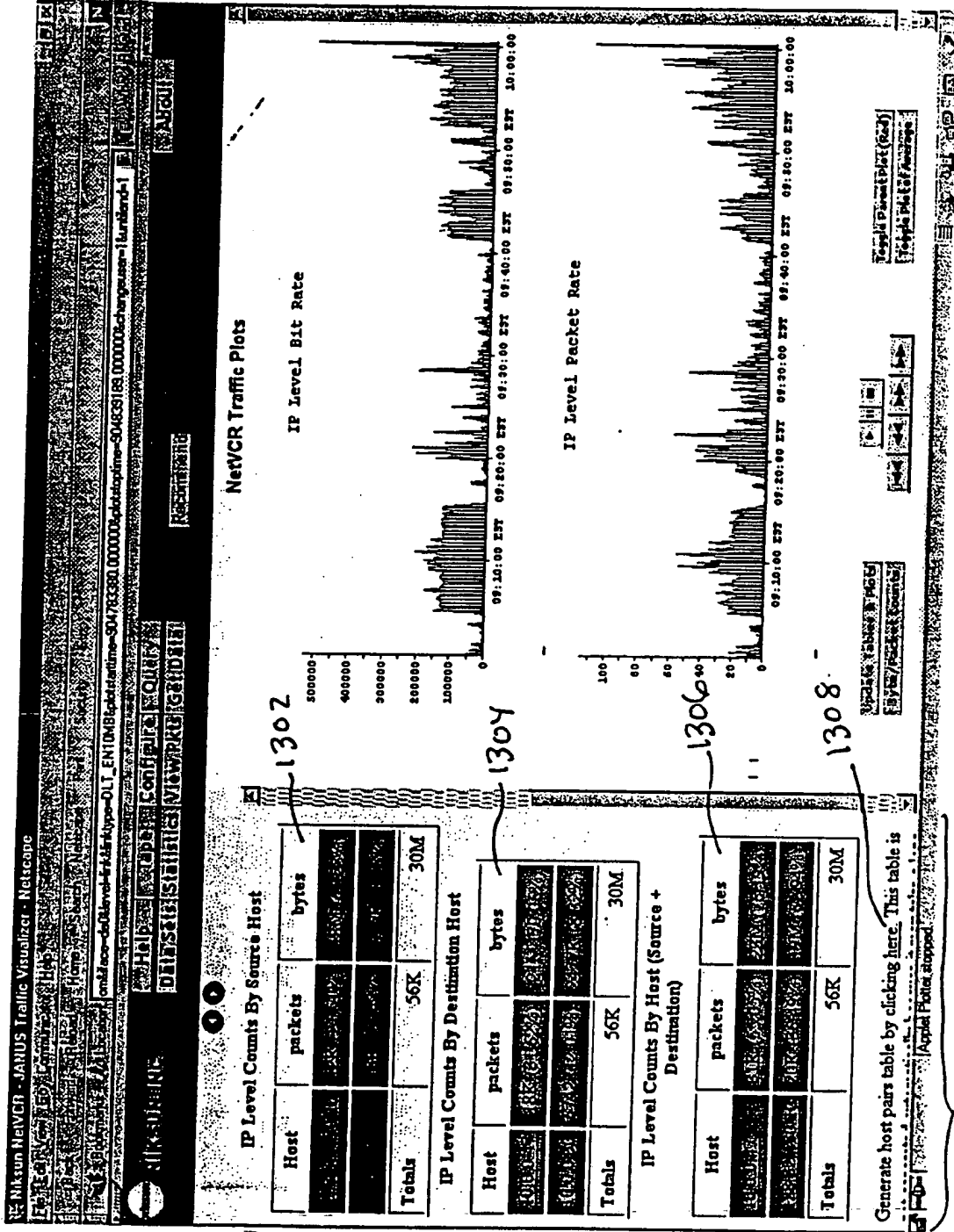

FIGURE 14

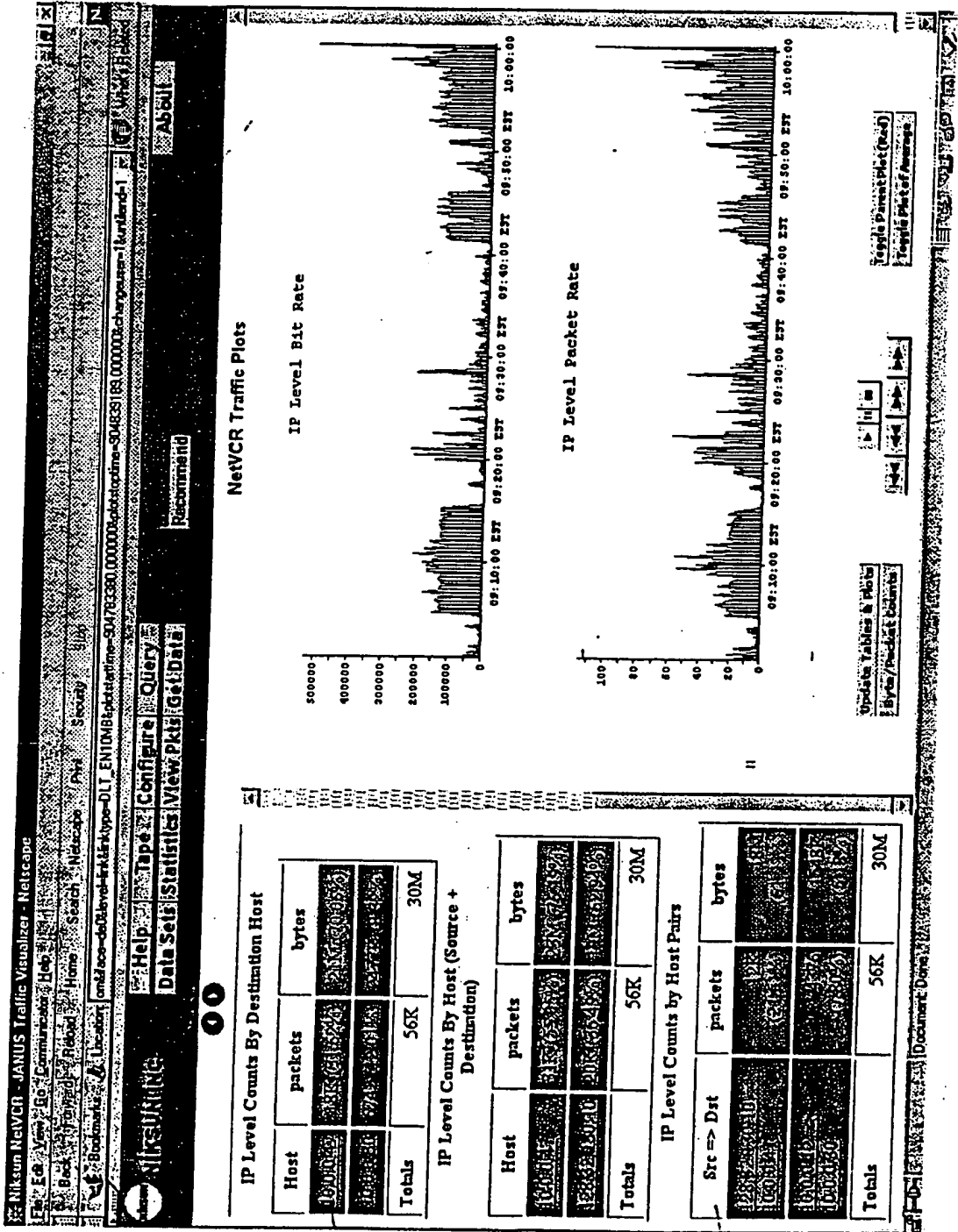

FIGURE 15

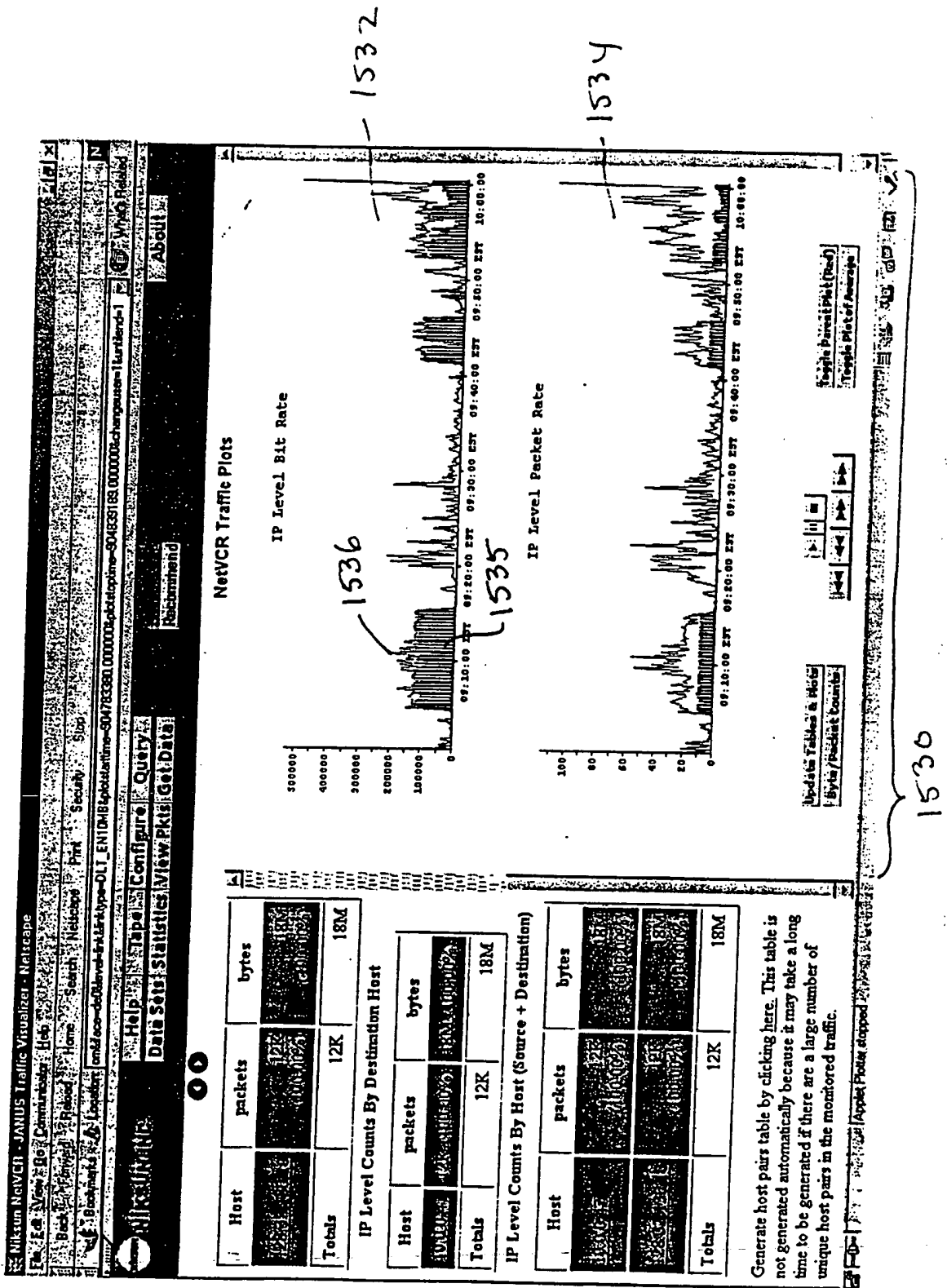
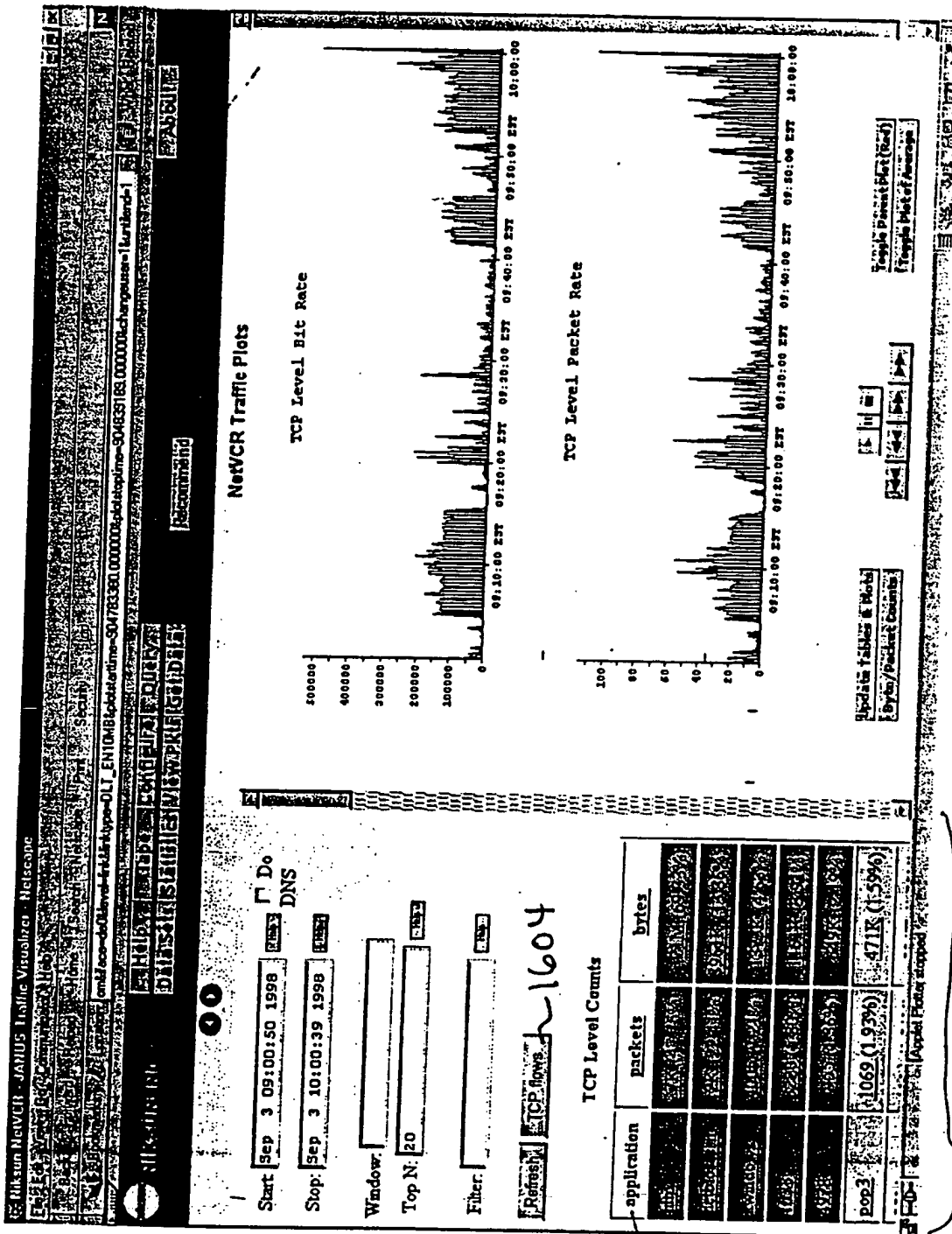

FIGURE 16



1610

FIGURE 17

TCP flows for de0 from Sep 3 09:00:50 1998 to Sep 3 10:00:39 1998 - Netscape

Start  
1701  
1702  
1706

Start	Stop	Orig host	Orig port	Orig bytes	Term host	Term part	Term bytes	RTT (sec)	Response (sec)	Rexmit bytes
Sep 3 09:01:04 1998 pkts plot	Sep 3 09:02:43 1998	10.0.0.47	33392	89	10.0.0.5	telnet	12043	N/A	N/A	0
Sep 3 09:02:23 1998 pkts plot	Sep 3 09:02:26 1998	10.0.0.101	openmath	644	10.0.0.30	netbios-ssm	710	0.000345	0.000252	0
Sep 3 09:03:45 1998 pkts plot	Sep 3 09:03:46 1998	10.0.0.40	2572	43	10.0.0.5	pop3	221	0.000933	0.380737	0
Sep 3 09:05:06 1998 pkts plot	Sep 3 09:05:07 1998	10.0.0.47	33388	361	128.32.130.10	http	0	N/A	N/A	0
Sep 3 09:06:07 1998 pkts plot	Sep 3 09:06:17 1998	10.0.0.40	2574	322	207.25.71.29	http	42357	0.426337	0.481845	892
Sep 3 09:06:09 1998 pkts plot	Sep 3 09:06:13 1998	10.0.0.40	2575	753	207.25.71.29	http	126	0.980415	1.017279	0
Sep 3 09:06:09 1998 pkts plot	Sep 3 09:06:13 1998	10.0.0.40	2576	752	207.25.71.29	http	126	0.998335	0.937072	0
Sep 3 09:06:09 1998 pkts plot	Sep 3 09:06:21 1998	10.0.0.40	2577	1076	207.25.71.29	http	18243	1.004437	1.171244	373
Sep 3 09:06:11 1998 pkts plot	Sep 3 09:06:17 1998	10.0.0.40	2578	759	207.25.71.29	http	126	1.170077	1.488473	0

TCP Flows

Document Done

FIGURE 18

ICP flows for de0 from Sep 3 09:00:50 1998 to Sep 3 10:00:39 1998 - NetScaps

Start	Stop	Orig host	Orig port	Orig bytes	Term host	Term port	Term bytes	RTT (sec)	Response (sec)	Reemit bytes
Sep 3 09:01:04 1998	Sep 3 09:02:43 1998	10.0.0.47	33392	89	10.0.0.5	telnet	12043	N/A	N/A	0
Sep 3 09:05:06 1998	Sep 3 09:05:07 1998	10.0.0.47	33388	361	128.32.130.10	ftp	0	N/A	N/A	0
Sep 3 09:13:00 1998	Sep 3 09:16:45 1998	10.0.0.47	33394	161	193.196.152.3	ftp	1690	0.667519	0.601587	211
Sep 3 09:18:48 1998	Sep 3 09:19:14 1998	10.0.0.47	33397	0	128.16.5.31	1337	560	N/A	5.638692	1
Sep 3 09:19:22 1998	Sep 3 09:19:39 1998	10.0.0.47	33398	0	128.16.5.31	lotusnote	697	0.429188	6.083521	2
Sep 3 09:19:59 1998	Sep 3 09:22:40 1998	10.0.0.47	33399	990024	10.0.0.31	xwindows	4584	0.001254	0.026585	0
Sep 3 09:23:58 1998	Sep 3 09:24:00 1998	10.0.0.47	ftp-data	635	10.0.0.31	1618	0	0.000669	N/A	0
Sep 3 09:23:20 1998	Sep 3 09:24:12 1998	10.0.0.31	1617	206	10.0.0.47	ftp	587	0.000836	0.044319	0
Sep 3 09:24:05 1998	Sep 3 09:24:07 1998	10.0.0.47	ftp-data	31406	10.0.0.31	1619	0	0.000648	N/A	0

1802

TCP Flows

Document Done

FIGURE 19

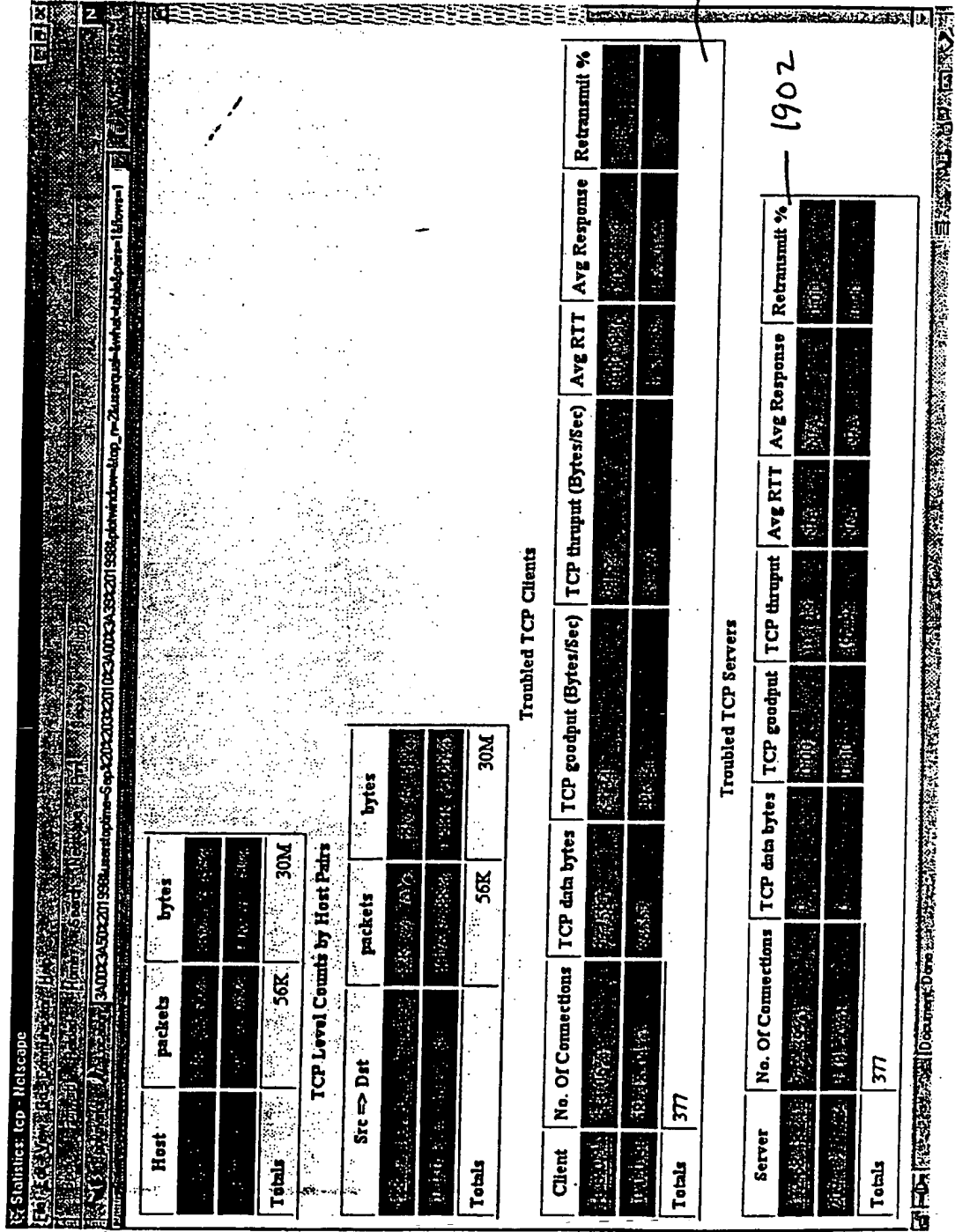

FIGURE 20

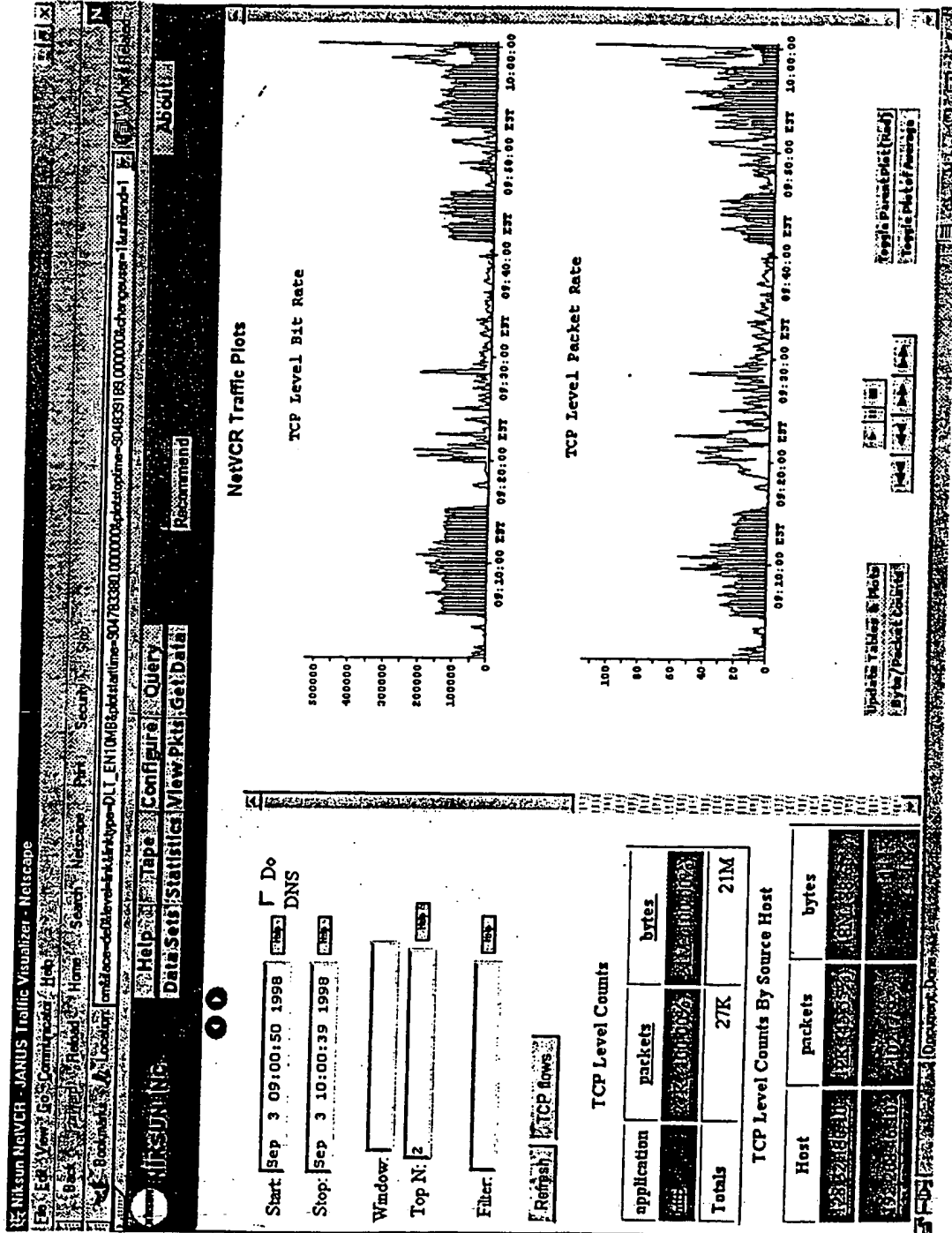



FIGURE 21

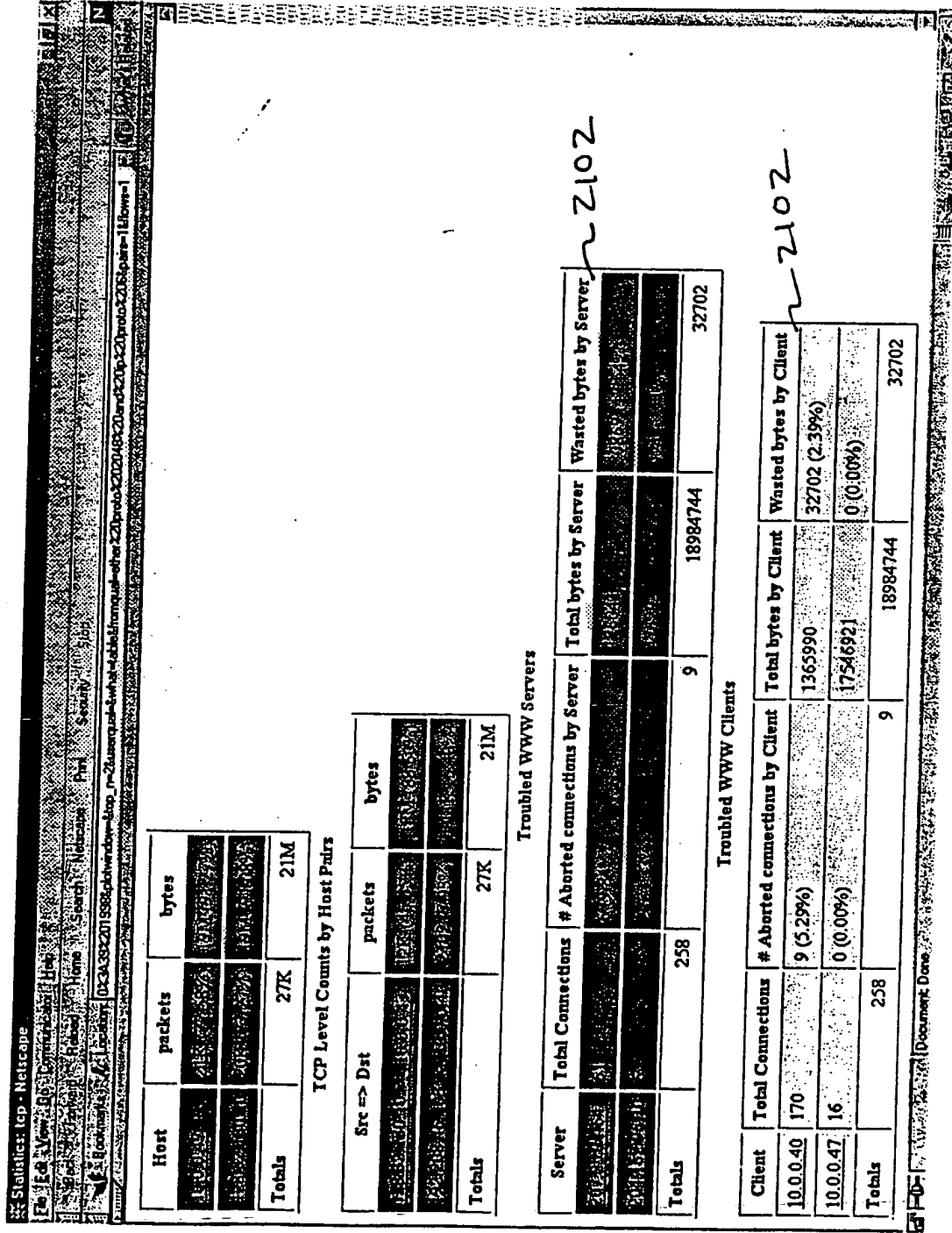

FIGURE 22

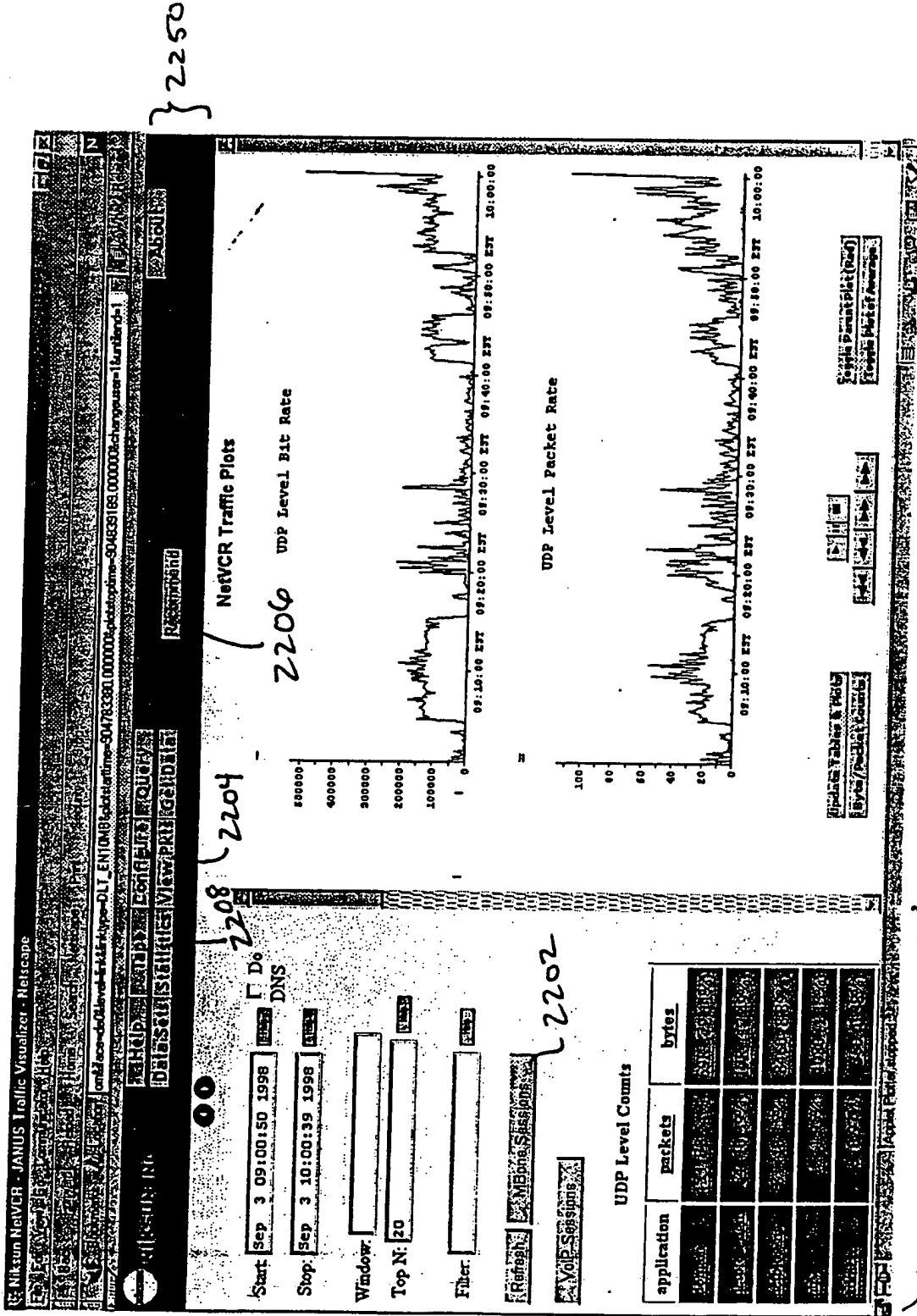

FIGURE 23

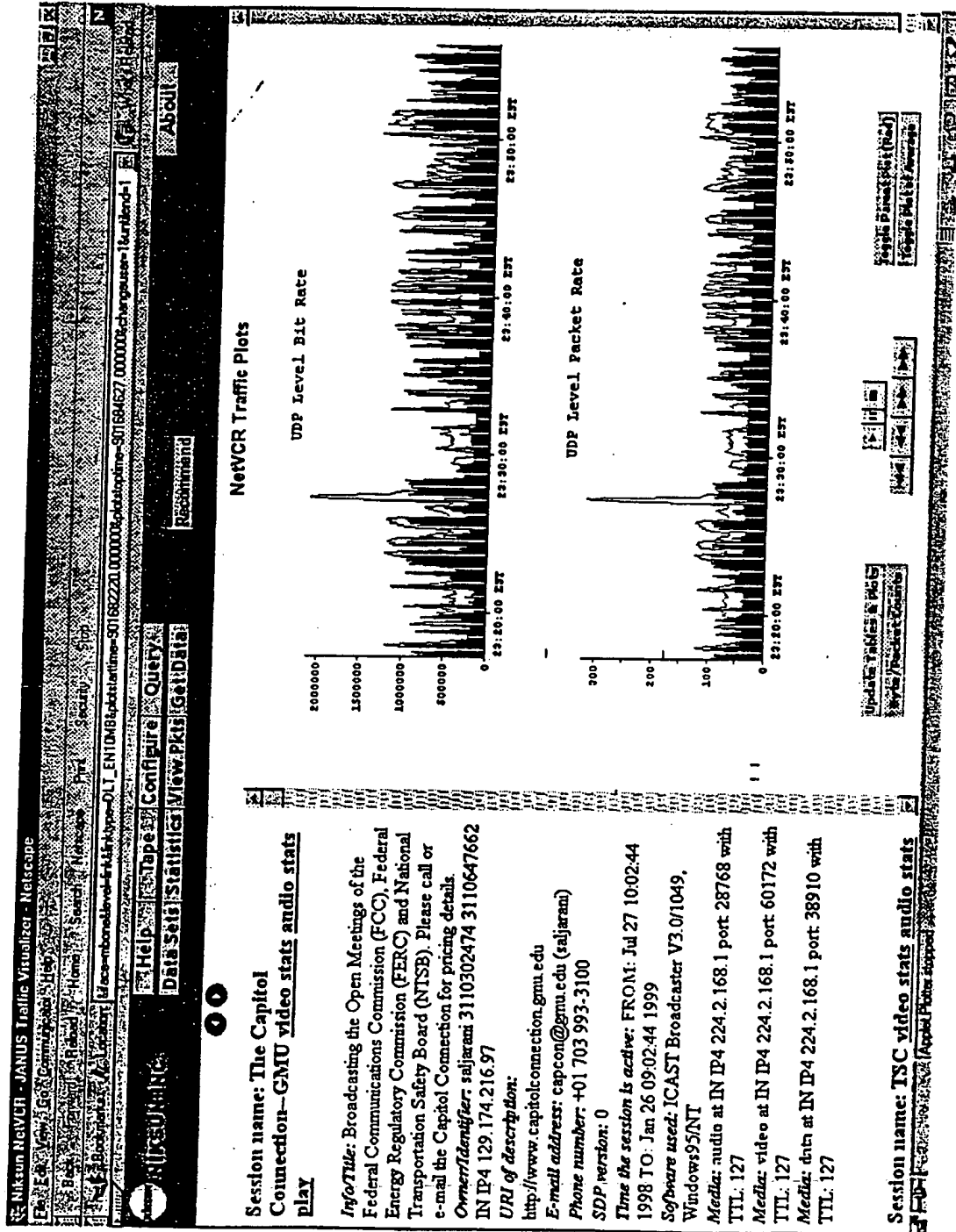

FIGURE 24

← 2404

NIKSUN JANUS NetVer TRAFFIC DUMP - Netscape

NIKSUN JANUS NetVer TRAFFIC DUMP for interface de0 from stiegl.miksum.com

BEGIN TIME: Sep 3 09:00:50 1998      END TIME: Sep 3 10:00:39 1998

Net/Broadcast Address to Name       Print Link Level Headers       Don't Convert Addresses To Names

Quick Dump       Print Absolute TCP Seq Num       Don't Print Timestamp

Hex Dump       Verbose Output       Very Verbose Output

```

03-SEP-98 09:10:123.150859 10.0.0.101.138 > 10.0.255.255.138: udp 223
03-SEP-98 09:10:128.443807 10.0.0.12.138 > 10.0.255.255.138: udp 221
03-SEP-98 09:10:223.544015 10.0.0.101.137 > 10.0.255.255.137: udp 50
03-SEP-98 09:10:223.545457 10.0.0.30.137 > 10.0.0.101.137: udp 62
03-SEP-98 09:10:228.494215 10.0.0.30.138 > 10.0.255.255.138: udp 226
03-SEP-98 09:10:228.482153 10.0.0.31.138 > 10.0.255.255.138: udp 215
03-SEP-98 09:10:228.490503 10.0.0.13.138 > 10.0.255.255.138: udp 231
03-SEP-98 09:10:228.511352 10.0.0.12.138 > 10.0.255.255.138: udp 221
03-SEP-98 09:04:10.311484 10.0.0.40.138 > 10.0.255.255.138: udp 201
03-SEP-98 09:10:06.690882 10.0.0.40.2573 > 10.0.0.5.53: 484 A7 www.cnn.com. (29)
03-SEP-98 09:10:06.696367 10.0.0.5.53 > 206.20.52.98.53: 32610+ A7 nls.ans.net. (29)
03-SEP-98 09:10:06.697168 10.0.0.5.53 > 206.20.52.98.53: 32611 A7 nls.ans.net. (25)
03-SEP-98 09:10:06.702713 206.20.52.98.53 > 10.0.0.5.53: 32610 1/10/10 A 147.225.1.2 (394)
03-SEP-98 09:10:06.702945 206.20.52.98.53 > 10.0.0.5.53: 32611 0/2/2 (99)
03-SEP-98 09:10:06.719441 10.0.0.5.53 > 206.20.52.97.53: 32611+ A7 cnn.com. (25)
03-SEP-98 09:10:06.753573 206.20.52.97.53 > 10.0.0.5.53: 32611* 10/2/2 A 207.25.71.28, A 207.25.71.29, A 207.25.71.20, A 207.25.71.21
03-SEP-98 09:10:06.7545183 10.0.0.5.53 > 10.0.0.40.2573: 48 11/2/2 CNAME cnn.com., A 207.25.71.29, A 207.25.71.20, A 207.25.71.21
03-SEP-98 09:10:06.754884 10.0.0.40.2590 > 10.0.0.5.53: 494 A7 ad.preferences.com. (36)
03-SEP-98 09:10:06.7549192 10.0.0.5.53 > 206.20.52.98.53: 32612+ A7 ad.preferences.com. (36)
03-SEP-98 09:10:06.7542168 206.20.52.98.53 > 10.0.0.5.53: 32612* 1/3/3 A 209.176.21.6 (176)
03-SEP-98 09:10:06.7546886 10.0.0.5.53 > 10.0.0.40.2590: 49* 1/3/3 A 209.176.21.6 (176)
03-SEP-98 09:10:137.317863 10.0.0.30.137 > 10.0.255.255.137: udp 50
03-SEP-98 09:10:138.819353 10.0.0.30.137 > 10.0.255.255.137: udp 50
03-SEP-98 09:10:139.577228 10.0.0.30.4970 > 10.0.0.5.53: 307+ A7 JSPNRPFTGSSSDIR.miksum.com. (45)
03-SEP-98 09:10:139.579832 10.0.0.5.53 > 10.0.0.30.4970: 307 NXDomain* 0/1/0 (108)
03-SEP-98 09:10:139.581461 10.0.0.30.4971 > 10.0.0.5.53: 308+ A7 JSPNRPFTGSSSDIR.qmetrix.com. (46)
03-SEP-98 09:10:139.584109 10.0.0.5.53 > 206.20.52.98.53: 32613+ A7 JSPNRPFTGSSSDIR.qmetrix.com. (46)
03-SEP-98 09:10:139.587116 206.20.52.98.53 > 10.0.0.5.53: 32613 NXDomain* 0/1/0 (113)
03-SEP-98 09:10:139.590877 10.0.0.5.53 > 10.0.0.30.4971: 308 NXDomain* 0/1/0 (113)
03-SEP-98 09:10:139.592419 10.0.0.30.4972 > 10.0.0.5.53: 309+ A7 JSPNRPFTGSSSDIR. (34)

```

2402

FIGURE 25

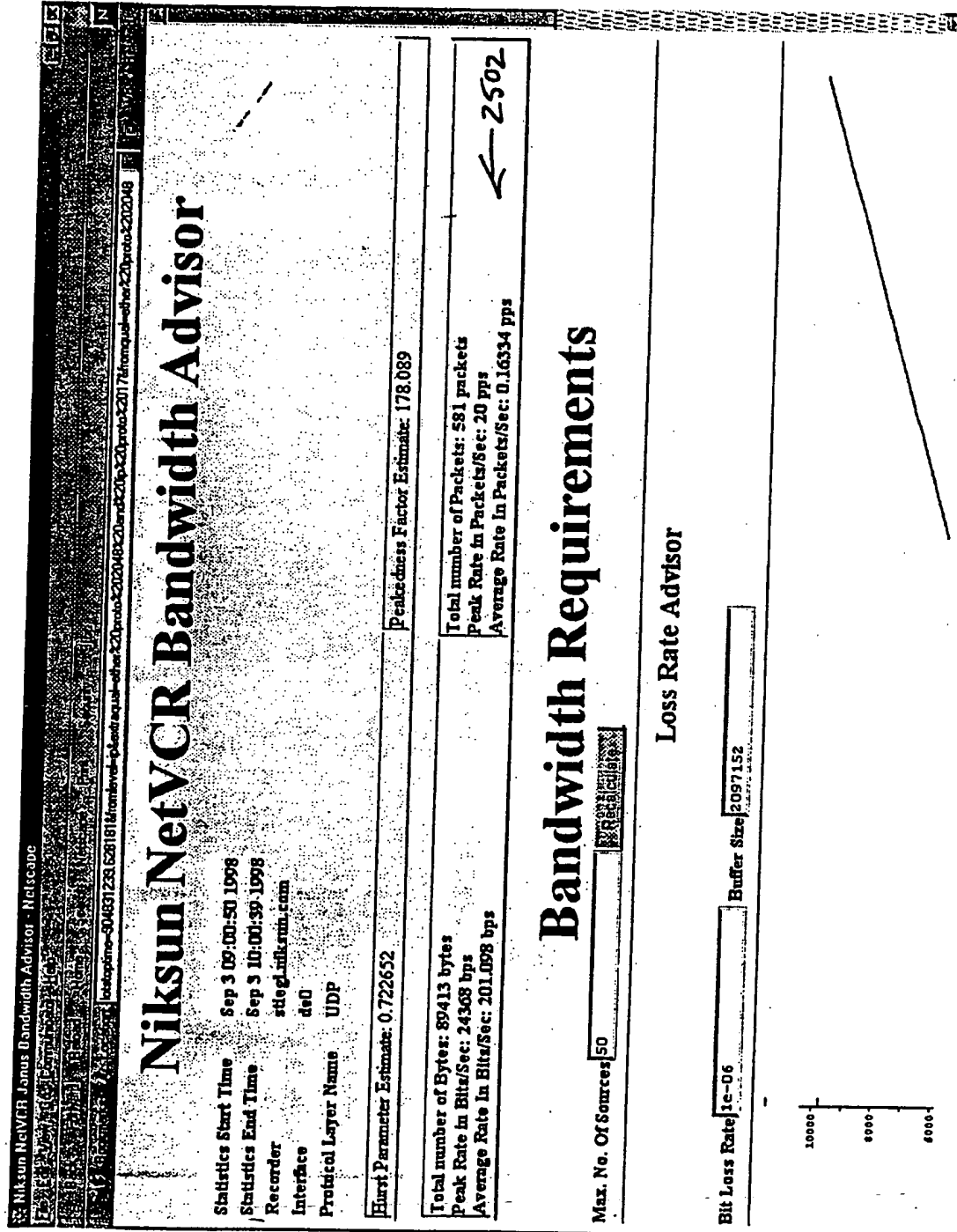

FIGURE 26

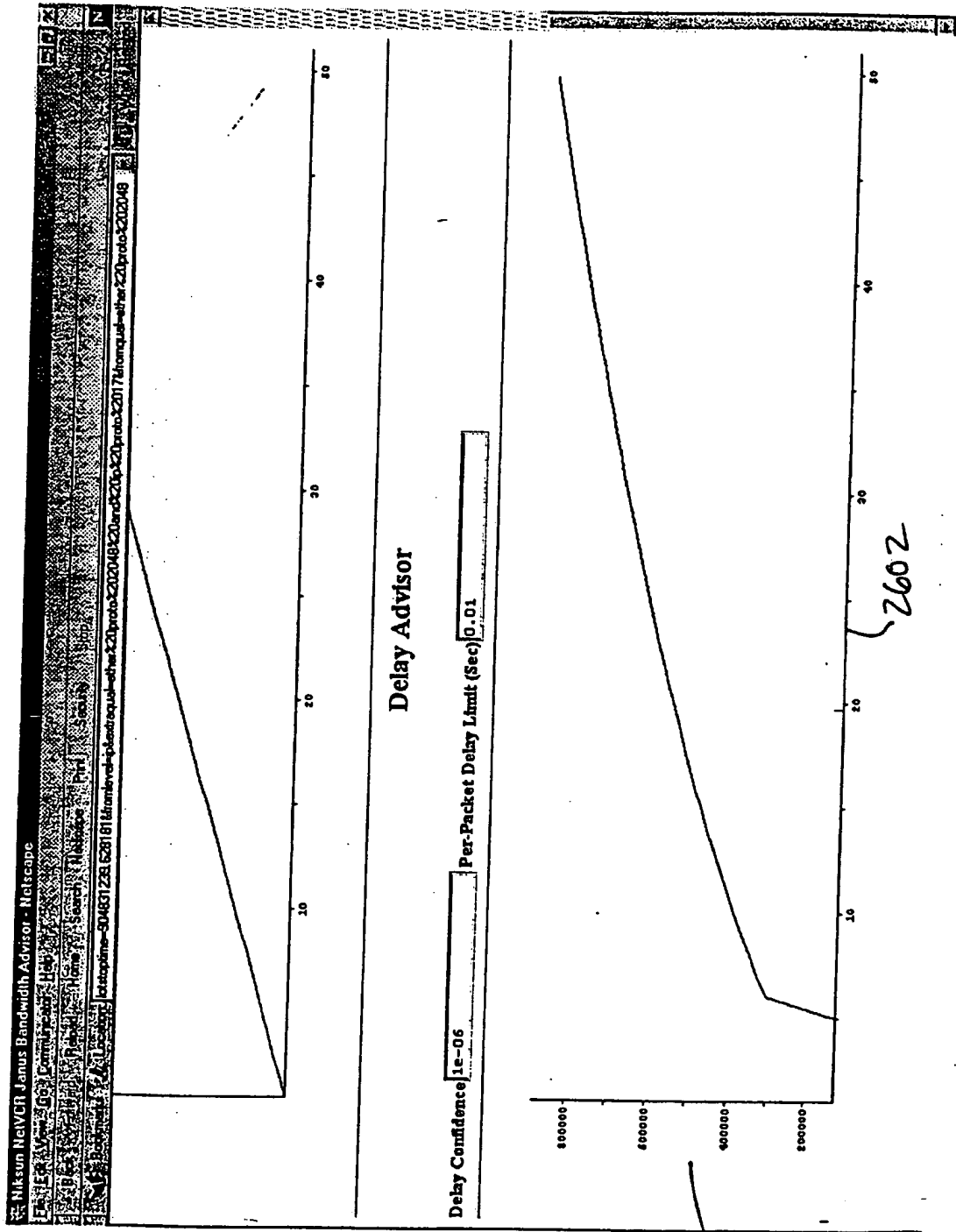

FIGURE 27

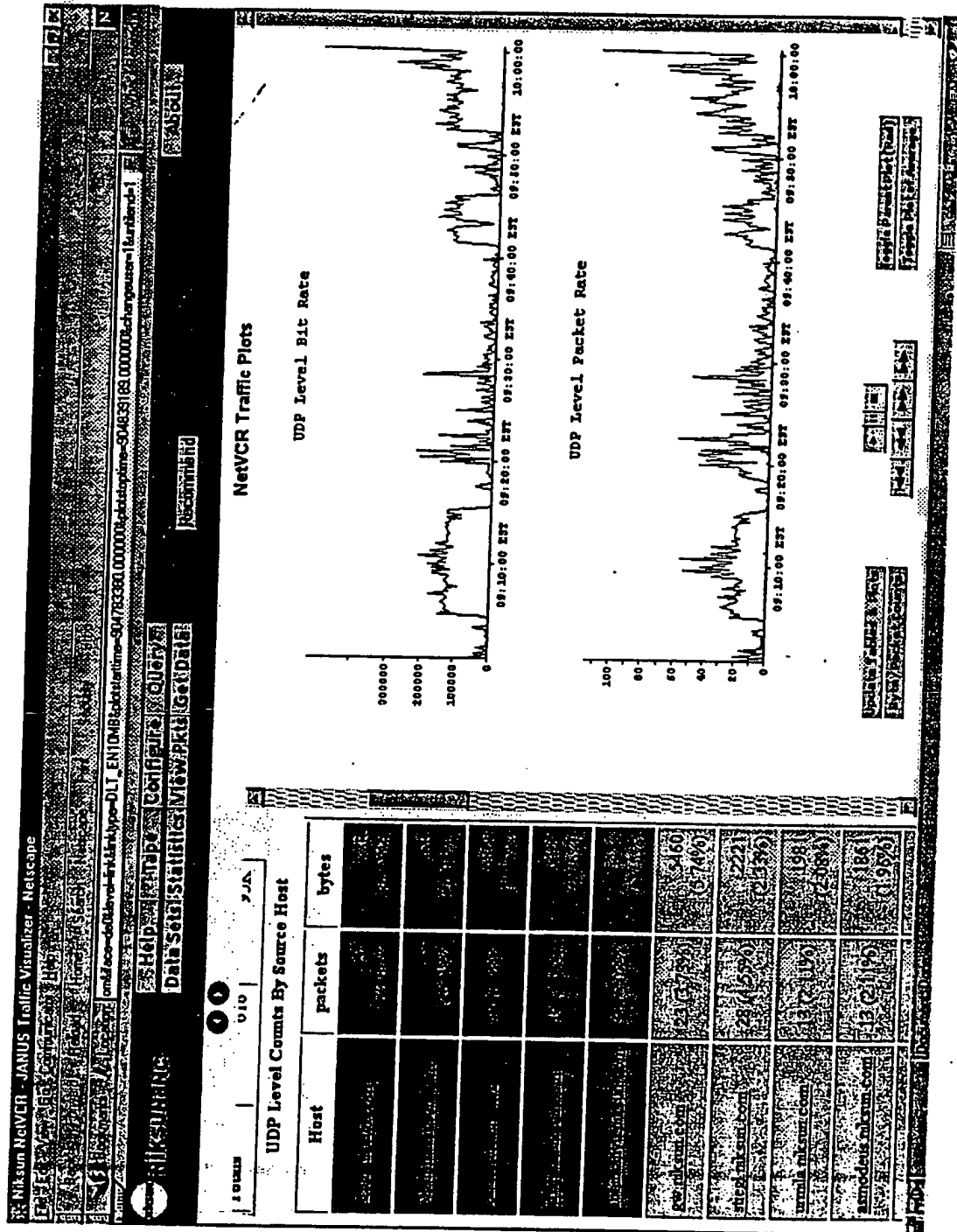
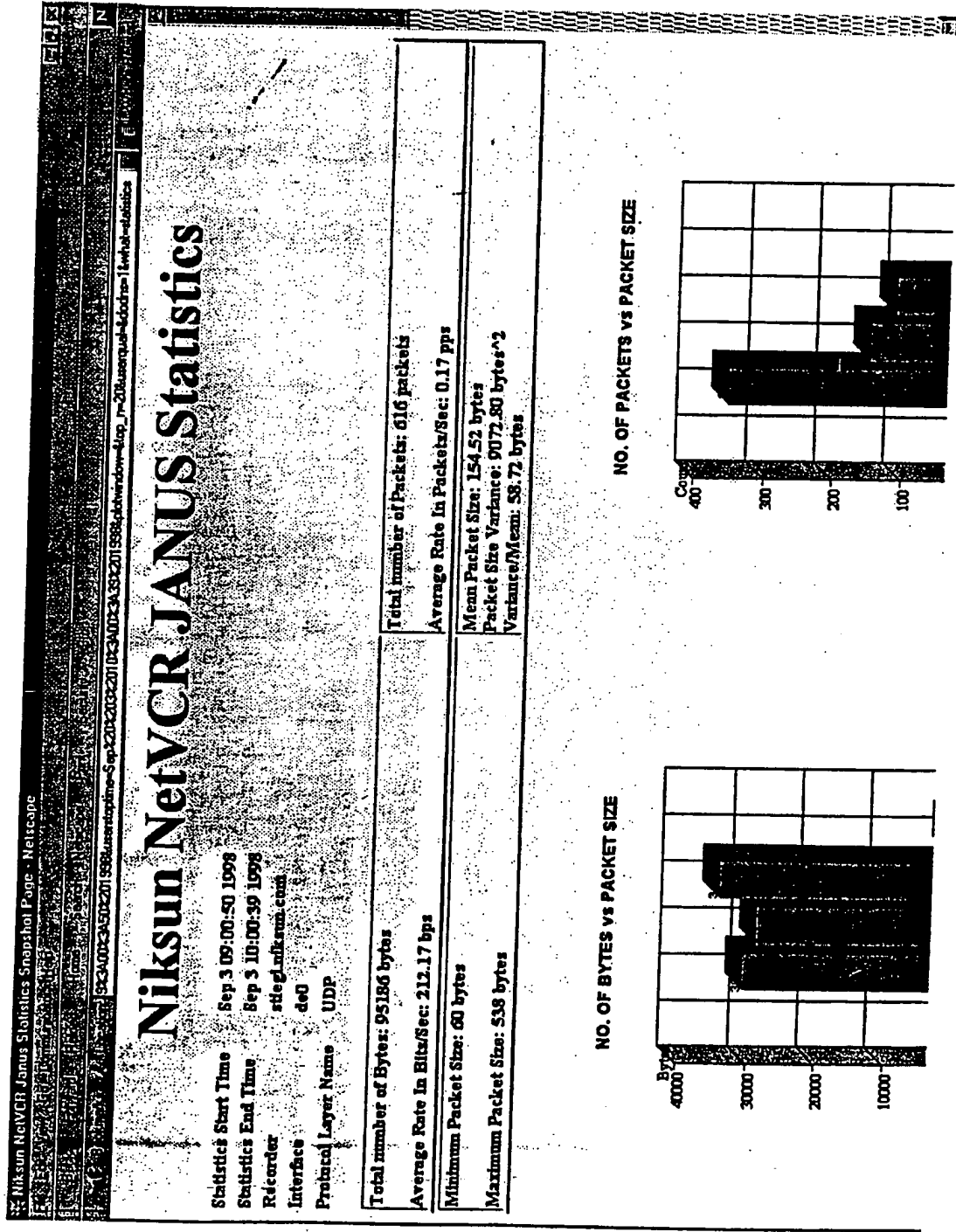

FIGURE 28





INTERNATIONAL SEARCH REPORT

International application No.  
PCT/US99/27969

A. CLASSIFICATION OF SUBJECT MATTER

IPC(7) :H04N 1/413

US CL :709/231, 224, 235, 239

According to International Patent Classification (IPC) or to both national classification and IPC

B. FIELDS SEARCHED

Minimum documentation searched (classification system followed by classification symbols)

U.S. : 709/231, 223, 224, 235, 239

Documentation searched other than minimum documentation to the extent that such documents are included in the fields searched

Electronic data base consulted during the international search (name of data base and, where practicable, search terms used)

C. DOCUMENTS CONSIDERED TO BE RELEVANT

Category*	Citation of document, with indication, where appropriate, of the relevant passages	Relevant to claim No.
A	US 5,787,253 A (MCCREERY et al) 28 July 1998, see fig. 2, and the abstract, see also col. 4, lines 4-47.	1,3-34, 36-43, 56-63, 73-78 -----
X		2,64-69, 70-72
A	US 5,812,528 A (VANDERVORT) 22,September 1998.	35,44-55
A	US 5,905,736 A (RONEN et al) 18,May 1999.	35,44-55
A	US 6,006,264 A (COLBY et al) 21, Deemberc 1999.	35; 44-55

Further documents are listed in the continuation of Box C.  See patent family annex.

* Special categories of cited documents:	*T* later document published after the international filing date or priority date and not in conflict with the application but cited to understand the principle or theory underlying the invention
*A* document defining the general state of the art which is not considered to be of particular relevance	*X* document of particular relevance; the claimed invention cannot be considered novel or cannot be considered to involve an inventive step when the document is taken alone
*E* earlier document published on or after the international filing date	*Y* document of particular relevance; the claimed invention cannot be considered to involve an inventive step when the document is combined with one or more other such documents, such combination being obvious to a person skilled in the art
*I* document which may throw doubts on priority claim(s) or which is cited to establish the publication date of another citation or other special reason (as specified)	*R* document member of the same patent family
*O* document referring to an oral disclosure, use, exhibition or other means	
*P* document published prior to the international filing date but later than the priority date claimed	

Date of the actual completion of the international search

22 MARCH 2000

Date of mailing of the international search report

05 APR 2000

Name and mailing address of the ISA/US  
Commissioner of Patents and Trademarks  
Box PCT  
Washington, D.C. 20231

Facsimile No. (703) 305-3230

Authorized officer

GLENTON BURGESS

Telephone No. (703) 305-4792

*James R. Matthews*